



marquis
FIREPLACE COLLECTION

PRODUCT
GUIDE

marquisfireplaces.net



EXTRAORDINARY STYLE IS NOW WITHIN SIGHT

Make a welcoming statement in your home with the warmth and evolutionary style of the Marquis Collection. From classic and clean to modern and sleek, you'll love the endless possibilities you can create!

Crafted entirely in Canada, each Marquis fireplace is built to the highest standards and made to last.



CONTENTS

FIREPLACES	5	MULTI-SIDED FIREPLACES	63	STYLING OPTIONS	99
Bentley	6	Atrium	64	Log Sets	100
Serene	18	Bentley ST	68	Accessories Gallery	102
Skyline	26	Enclave	74	Flame Chart	104
Solace	30	Infinite	86		
Solara II	34	Multi-sided Viewing Area Dimensions	90		
Fireplace Viewing Area Dimensions	38			PRODUCT SPECIFICATIONS	105
FREE STANDING STOVES	39	OUTDOOR LIVING	91	WARRANTY	111
Sentinel	40	Aurora	92		
Titan	42	Bola	94		
Vantage	44	Outdoor Viewing Area Dimensions	98		
Stove Viewing Area Dimensions	48				
INSERTS	49				
Capella 26	50				
Capri 24/34/44	54				
Insert Viewing Area Dimensions	62				

FIREPLACES



BENTLEY

ZERO CLEARANCE DIRECT VENT GAS FIREPLACE

BRING THE BIG VIEW INDOORS.

With an expansive glass viewing area and clever designer options for customizing the look to suit your personal style, the **BENTLEY** is generating some serious attention.

Available in a range of sizes and styles, you can choose from our mid efficient rated fireplace for ambiance and taking the chill out of the room, or higher efficient version for additional warmth.

Customize the look with your choice of surround, brick liner, oak, birch, or driftwood log sets, ember glass in five color options, cannonballs or rocks.

With so much style and attention to detail, it's no wonder people are focused on the view indoors!



View the full Bentley brochure here.

BENTLEY 34

BOTTOM LEFT

BENTLEY 34 (ZCV34NE2)
MqSTONE Decorative Stones
ZCV34PL Liner (Porcelain Reflective)

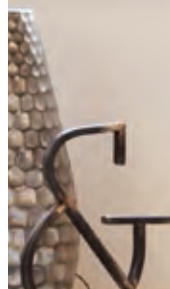



LEFT

BENTLEY 34 (ZCV34NE2)
 MQLOGF34OAK Log Set (Split Oak)
 ZCV34RLH Liner (Herringbone Brick)



BENTLEY 34 (ZCV34NE2)
 MQLOGF34BW Log Set (Birchwood)
 ZCV34RLT Liner (Traditional Brick)



BENTLEY 34 (ZCV34NE2)
 MQG5B Glass Media (Black)
 ZCV34PL Liner (Porcelain Reflective)



BENTLEY 34 (ZCV34NE2)
 MQRBD3 Log Set (Driftwood)
 ZCV34PL Liner (Porcelain Reflective)

BENTLEY 39/42

BENTLEY 39 (ZCV39NHE2)
MQL0GF9 Log Set (Split Oak)
ZCV39RLH Liner (Herringbone Brick)
MQ39DD2BL Designer Door (Series 2)



BENTLEY 39 (ZCV39NHE)
MQ39D Log Set (Driftwood)
MQSTONE Decorative Stones
VLBIT6 Log Bits (Small)
ZCV39PL Liner (Porcelain Reflective)
ZCV39S1PFBL Surround (Picture Frame 4")



BENTLEY 39/42

BENTLEY 39 (ZCV39NE)

ZCV39GT Glass Tray
MQG5ZG Glass Media (Zircon Glacier Ice)
ULK2 Universal Lighting Kit
ZCV39PL Liner (Porcelain Reflective)
ZCV39S2PFBL Surround (Picture Frame 1-5/8")



BENTLEY 39 (ZCV39NE)
MQLOGF9 Log Set (Split Oak)
ZCV39RLS Liner (Stacked Brick)
MQ39DD2BL Designer Door (Series 2)



BENTLEY 39 (ZCV39NE)
MQLOGF9 Log Set (Split Oak)
ZCV39RLT Liner (Traditional Brick)
MQ39DD3BL Designer Door (Series 3)



BENTLEY 39 (ZCV39NE)
LOGF3 Log Set (Split Oak)
ZCV39RLH Liner (Herringbone Brick)
MQ39DD1BL Designer Door (Series 1)

BENTLEY 42 (ZCV42NE2)
 MQ42D Log Set (Driftwood)
 ZCV42GT Glass Tray
 ZCV42PL Liner (Porcelain Reflective)
 ZCV42S1BL Surround (Hearth Mount 4")



BENTLEY 39 (ZCV39NE)
 ZCV39GT Glass Tray
 MQSTONE Decorative Stones
 ZCV39PL Liner (Porcelain Reflective)



BENTLEY 42 (ZCV42NE)
 MQLOGF39BW Log Set (Birchwood)
 ZCV42PL Liner (Porcelain Reflective)



BENTLEY 39 (ZCV39NE)
 ZCV39GT Glass Tray
 MQROCK3 Contemporary Rocks (Multi-Colored)
 ZCV39PL Liner (Porcelain Reflective)

GO **BIG.**

When the view is this big, it must be the **BENTLEY 48**. This big brother of the popular Bentley is getting some serious attention and lots of second looks from home owners wanting to enjoy a statement fireplace.

An expansive glass viewing area and beautiful designer options allow you to customize the look to your own style. Take the chill out of the room with this heater-rated fireplace, and bask in some serious warmth.

Wow – we made you look, didn't we?



View the full Bentley 48 brochure here.

BENTLEY 48 (MQZCV48NE2)
MQL0GF48B Log Set (Burnt Oak)
ZCV48RLH Liner (Herringbone Brick)





BENTLEY 48

BENTLEY 48 (M0ZCV48NE2)
MQL0GF39BW Log Set (Birchwood)
MQBBITS Log Bits (Birchwood)
ZCV48RLS Liner (Stacked Brick)





BENTLEY 48 (MQZCV48NE2)
MQZCV48GT Glass Tray
MQG5C Glass Media (Bronze)
ZCV48PL Liner (Porcelain Reflective)



BENTLEY 48 (MQZCV48NE2)
MQLOGF48 Log Set (Oak)
ZCV48RLS Liner (Stacked Brick)
MQ48DD3BL Designer Arch Door (Series 3)

LOG SETS



MQRBD3 – Driftwood
BENTLEY 34



MQRBRW – Birchwood
BENTLEY 34



MQLOGF34OAK – Oak
BENTLEY 34



MQLOGF34BW – Birchwood
BENTLEY 34



MQLOGF453 – Driftwood
BENTLEY 34



LOGC44 – Burnt Oak
BENTLEY 34



MQLOGF9 – Split Oak
BENTLEY 39 / 42



LOGF3 – Split Oak
BENTLEY 39 / 42



MQ39D – Driftwood*
BENTLEY 39 / 42



MQLOGF39BW – Birchwood
BENTLEY 39 / 42 / 48



MQ42D – Driftwood*
BENTLEY 39 / 42



MQLOGF48D – Driftwood*
BENTLEY 48



MQLOGF48 – Split Oak
BENTLEY 48



MQLOGF48B – Burnt Oak
BENTLEY 48

**Glass Tray Required*

DESIGNER DOORS

BENTLEY 39 / 42 / 48



DD1 – Series 1



DD2 – Series 2



DD3 – Series 3 (Arched)



Black

WALL SURROUND

GLASS AND STONE MEDIA OPTIONS*



MQG5ZG – Zircon Glacier Ice Glass



MQG5A – Cobalt Ember Glass



MQG5B – Black Ember Glass



MQG5C – Bronze Ember Glass

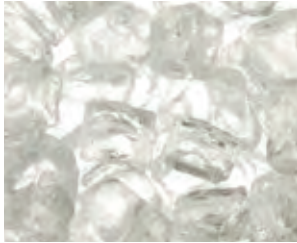

MQG5W – White Ember Glass



MQEMBER – Ember Chunks



MQSTONE – Decorative Stones



MQROCK2 – Natural Rocks



RBCB1 – Multi-Colored Cannonballs

**Glass Tray Required*

LINERS



RLT – Traditional Brick
BENTLEY 34 / 39 / 42 / 48



RLH – Herringbone Brick
BENTLEY 34 / 39 / 42 / 48



RRH – Red Herringbone Brick
BENTLEY 39 / 42



RLS – Stacked Brick
BENTLEY 39 / 42 / 48



RLF – Fluted
BENTLEY 39 / 42 / 48



PL – Porcelain Reflective
BENTLEY 34 / 39 / 42 / 48

SERENE

ZERO CLEARANCE DIRECT VENT GAS FIREPLACE

A FEELING OF SERENITY.

At the end of a busy day, cozy up to the **SERENE**. With beautiful designer details and the highest quality craftsmanship, Serene combines pure comfort with a wow-factor that comes from your choice of rocks and driftwood, decorative stones, cannonballs or ember glass. Relax and unwind the Serene way.



View the full Serene brochure here.



SERENE 47

BOTTOM LEFT

SERENE 47 (ZCVRB47N)

Glass Media (Bronze)

MQZCVRB47RLF Liner (Fluted)

(Shown as a Vented Chase – top of chase is open.)



BELOW

SERENE 47 (MQZCVRB47NE2)
MQRBRW Log Set (Birchwood)
ZCVRB47S1SS Surround (Stainless Steel)
MQSTONE10 Decorative Stones
ZCVRB47PL Liner (Porcelain Reflective)



SERENE 60

SERENE 60 (ZCVRB60NE)

MQSTONE Decorative Stones
ZCVRB60PL Liner (Porcelain Reflective)
(Shown with Vented Chase Option – VL60EG Front Enclosed Grill)



SERENE 60 (MQZCVRB60NE2)
 MQ46D Log Set (Driftwood)
 MQSTONE Decorative Stones
 MQRB60RLS Liner (Stacked Brick)
 ZCVRB60S1BL Surround (Black)
 (Shown as a Vented Chase – top of chase is open)



SERENE 60 (ZCVRB60N)
 RBCB1 Stone Media (Cannonballs)
 ZCVRB60PL Liner (Porcelain Reflective)



SERENE 60 (ZCVRB60N)
 MQG5W Glass Media (White)
 ZCVRB60PL Liner (Porcelain Reflective)

SERENE 72

SERENE 72 (MQZCVRB72NE2)
ZCVRB72S1BL Surround (Black)
MQVL72RGB Back Liner (Reflective Glass)
MQVL72RGE End Liners (Reflective Glass)
(Shown as a Vented Chase with optional VL72EGS Enclosure Grill)



SERENE 72 (ZCVRB72NE)
RBCB1 Stone Media (Cannonballs)
ZCVRB72PL Liners (Porcelain Reflective)



SERENE 72 (ZCVRB72NE)
MQG5W Glass Media (White)
MQSTONE Decorative Stones
ZCVRB72PL Liners (Porcelain Reflective)



SERENE 72 (ZCVRB72NE)
ZCVRB72S1BL Surround (Black)
MQRBRW Log Set (Birch)
MQVL72RLFB2 Back Liner (Fluted)
MQVL60RLF2 End Liners (Fluted)



LOG SETS



MQ46D – Driftwood



MQRBD1 – Driftwood with Rocks



MQRBD2 – Driftwood



MQLOAK1 – Oak



MQRBD3/MQRBD4 – Driftwood



MQRBRW – Birchwood

GLASS AND STONE MEDIA OPTIONS*



MQG5ZG – Zircon Glacier Ice Glass



MQG5A – Cobalt Ember Glass



MQG5B – Black Ember Glass



MQG5C – Bronze Ember Glass

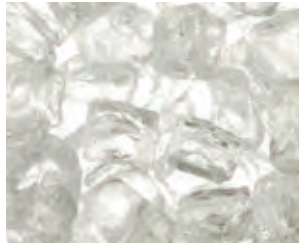

MQG5W – White Ember Glass



MQEMBER – Ember Chunks



MQSTONE – Decorative Stones



MQROCK2 – Natural Rocks



RBCB1 – Multi-Colored Cannonballs

**Glass Tray Required*

LINERS



RLS – Stacked Brick
SERENE 60 / 72



RLF – Fluted
SERENE 47 / 72



PL – Porcelain Reflective
SERENE 47 / 60 / 72



RG – Reflective Glass
SERENE 72

VENTED CHASE OPTION

The chase of the appliance may be vented to achieve Cool Touch Walls or reduced Mantel Clearances. The following options are available to vent the chase:

- The top of the chase can be left open.
- A grill can be installed on the front of the chase.
- If the chase bumps out into the room, side grills can be installed on each side of the chase.

See illustrations and manual for further information.

Minimum enclosure height for a vented chase is measured from bottom of fireplace, ventilation of minimum free air opening is required. Choose between our Enclosure Grills (Front or Sides) or Custom Grill (if custom grills are used the louvers cannot slope) or adequate ventilation opening as stated in the manual. Grill or opening must meet minimum (as specified in the installation manual) of chase top/ceiling.

NOTE: To vent the fireplace chase, removal of vent shields from the fireplace is required.

WALL SURROUNDS



Black



Stainless Steel

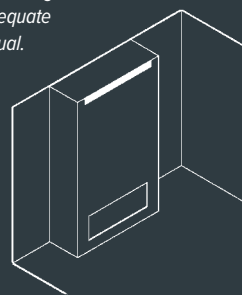

Framing to ceiling with open front

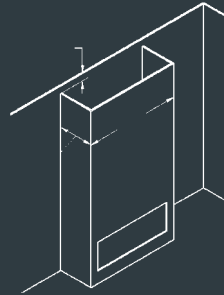

Open chase framing with enclosure min. below ceiling

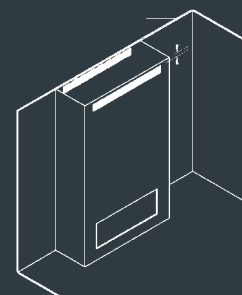

Framing to ceiling with vents at front and back

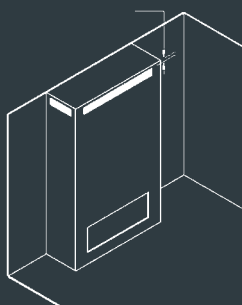

Framing to ceiling with front or side vents

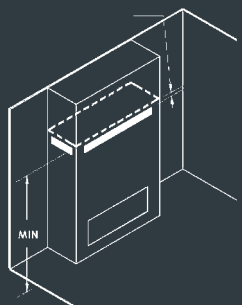

Framing to ceiling, minimum enclosure with front or side vents

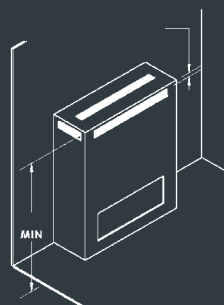

Minimum enclosure with front or side vents

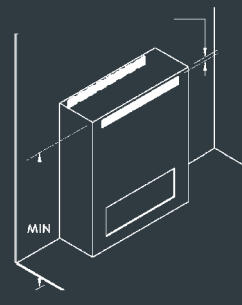

Minimum enclosure with front and back vents

SKYLINE

ZERO CLEARANCE DIRECT VENT GAS FIREPLACE

ENJOY THE VIEW.

There is nothing subtle about this **SKYLINE**.

Its pure sophistication makes a statement with wide-view appeal and flexibility. Choose from the rocks and driftwood, decorative stones or ember glass in a choice of colors for a sleek contemporary look.



View the full Skyline brochure here.

BOTTOM LEFT

SKYLINE (ZCVRB3622N)
Ember Glass (Bronze)
Z3622PRL Liner (Porcelain Reflective)
ZCVRB36SWFBL Flatt Surround (Black)
ULK2 Universal Light Kit (Optional)



BELOW

SKYLINE (MORB4236NT)

Ember Glass (White)

HB42CVCK Designer Clean View Circulating Kit



SKYLINE

SKYLINE (ZCVRB3622N)

Ember Glass (Bronze)
MQRBD1 Media Set (Contemporary Rock & Driftwood)
Z3622PRL Liner (Porcelain Reflective)
ZCVRB36SBL Edge Surround (Black)



SKYLINE (ZCVRB3622N)

Ember Glass (Bronze)
MQRBD1 Media Set (Contemporary Rock & Driftwood)
Z3622PRL Liner (Porcelain Reflective)



SKYLINE (ZCVRB3622N)

Ember Glass (Bronze)
Z3622PRL Liner (Porcelain Reflective)
ZCVRB36SSS Edge Surround (Stainless Steel)
ULK2 Universal Light Kit (Optional)

LOG SETS



MQRBD1 – Rock & Driftwood Set



MQRBD4 – Dirftwood

GLASS AND STONE MEDIA OPTIONS*

**Glass Tray Required*



MQG5ZG – Zircon Glacier Ice Glass



MQG5A – Cobalt Ember Glass



MQG5B – Black Ember Glass



MQG5C – Bronze Ember Glass

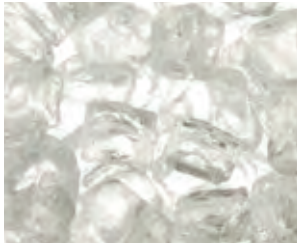

MQG5W – White Ember Glass



MQEMBER – Ember Chunks



MQSTONE – Decorative Stones



MQROCK2 – Natural Rocks

WALL SURROUNDS



ZCVRB36SBL – Edge Black
ZCVRB3622 ONLY



ZCVRB36SSS – Edge Stainless Steel
ZCVRB3622 ONLY



ZCVRB36SWFBL – Flatt Black
ZCVRB3622 ONLY

LINER



PL – Porcelain Reflective
ZCVRB3622 ONLY

SOLACE

ZERO CLEARANCE DIRECT VENT GAS FIREPLACE

FIND YOUR SOLACE.

Imagine lively gatherings or times of quiet reflection in front of the beautiful **SOLACE**. Available in four sizes, the Solace allows you to transform your fireplace into something truly unique.

With so much style and attention to detail, the Solace is available in a range of styles. You can choose from our mid-efficient rated fireplace for ambiance and taking the chill out of the room, or our higher-efficient version for additional warmth.



View the full Solace brochure here.

BOTTOM LEFT

SOLACE (HBZDV4736N)
LOGF36 Log Set (Split Oak)
VLBIT4 Log Bits
HB47RRH Liner (Herringbone Brick)
HB47CVCK Designer Clean View Circulating Kit



BELOW

SOLACE II (HBZDV4228NE)
MOLOGF36BW Log Set (Birch)
HB42PL Liner (Porcelain Reflective)
HB42GBL Grill Kit (Black)





ABOVE

SOLACE (MQHBZDV4236N)
 LOGF36 Log Set (Split Oak)
 HB42GBL Grills (Black)
 HB42RLT Liner (Traditional Brick)

LEFT

SOLACE II (HBZDV4224N)
 LOGC44 Log Set (Oak)
 HB42GBL Grills (Black)
 HB42RLT Liner (Traditional Brick)

LOG SETS



LOGF36 – Split Oak
SOLACE



LOGC44
SOLACE II



MQLOGF36BW – Birch
SOLACE II

STONE MEDIA OPTIONS*



MQROCK2 – Natural Rocks

**Requires Support Platform (Solace I only)*

LINERS



PL – Porcelain Reflective



RLT – Traditional Brick



RLH – Herringbone Brick



RRH – Red Herringbone Brick
HB47 ONLY

SOLARA II

ZERO CLEARANCE DIRECT VENT GAS FIREPLACE

ADD SOME SIZZLE.

Incredibly versatile, the **SOLARA** is perfectly at home with a classic mantle or contemporary wall surround. Plus you can also choose a log set or a contemporary rock set.



[View the full Solara brochure here.](#)

BOTTOM LEFT

SOLARA II (ZCV3622N)
LOGC51 Log Set (Split Oak)
ZCV3622PRL Liner (Porcelain Reflective)
ZCV36SWFBL Surround (Flatt – Black)



BELOW

SOLARA II (ZCV3622N)
MLOGC23 Log Set (Driftwood)
ZCV3622PRL Liner (Porcelain Reflective)
ZCV36SWFBL Surround (Flatt – Black)



SOLARA II

SOLARA II (ZCV3622N)
LOGC51 Log Set (Split Oak)
ZCV3622ML Liner (Metal Brick)



LOG SETS



MQLOGC23 – Driftwood



LOGC51 – Split Oak



MQROCK2 – Natural Rocks

STONE MEDIA

LINERS



PL – Porcelain Reflective



ML – Metal Brick

SURROUNDS



ZCV36S1BL – Hearth Mount Black



ZCV36SWFBL – Flatt Black



SOLARA II (ZCV3622N)
MQLOGC23 Log Set (Driftwood)
Z3622PRL Liner (Porcelain Reflective)
ZCV36S1BL Surround (Hearth Mount – Black)

VIEWING AREA DIMENSIONS

FIREPLACES

BENTLEY

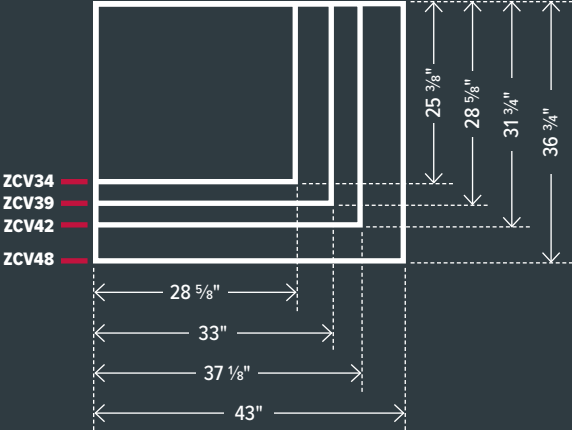

SOLACE

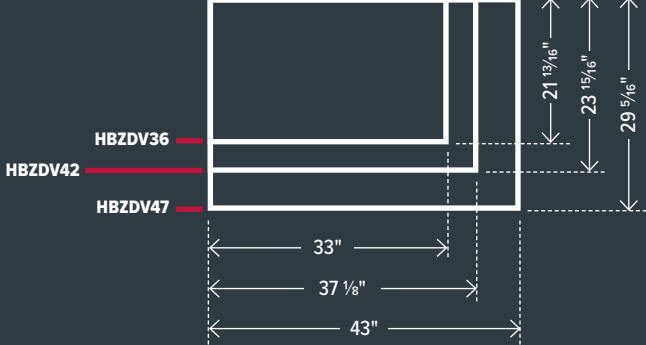

SKYLINE

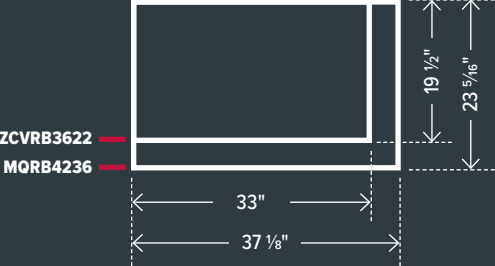

SOLARA II

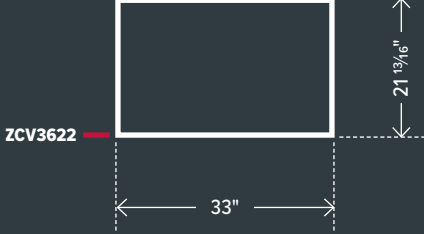

SERENE

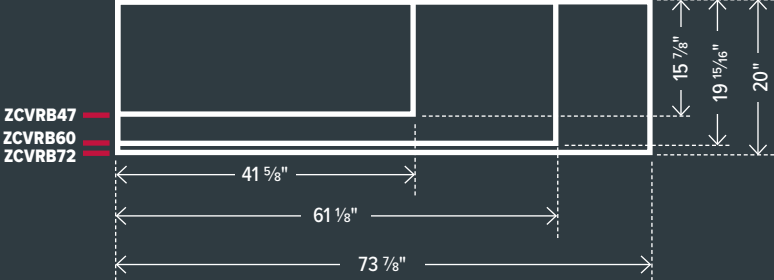

FREE STANDING STOVES



SENTINEL

FREE STANDING DIRECT VENT GAS STOVE

SENTINEL (FDV350NE2)
LOGF35 Log Set (Fibre Oak with Embers)
F35DB Door (Black with Ceramic Glass)



STANDING AT ATTENTION.

The **SENTINEL** is an efficient Free standing Direct Vent Gas Stove. Your best choice for installation anywhere throughout your home.



View the full Sentinel brochure here.

SENTINEL > ACCESSORIES

LOG SET



LOGF35 – Fibre Oak with Embers

LINER



F35RL – Traditional Brick

SAFETY SCREEN BARRIER



TITAN

FREE STANDING DIRECT VENT GAS STOVE

A CHAMPION OF STRENGTH.

The **TITAN** Direct Vent Gas Stove provides sealed combustion where it draws in outside air. This model can be vented either horizontally or vertically.



View the full Titan brochure here.

TITAN (FDV200SN)
LOGF200 Log Set (Split Oak)
FDV200RL Liner (Traditional Brick)

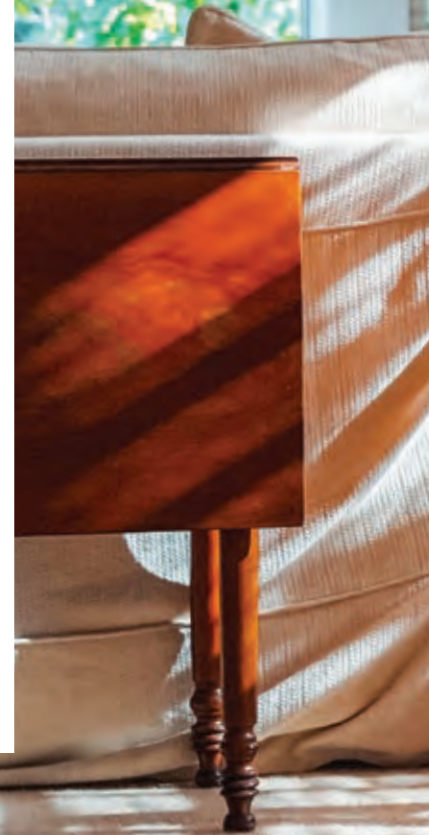

TITAN > ACCESSORIES

LOG SET



LOGF200 – Split Oak

LINER



FDV200RL – Traditional Brick



TITAN (FDV200SNE2)
LOGF200 Log Set (Split Oak)
FDV200RL Liner (Traditional Brick)



VANTAGE

FREE STANDING DIRECT VENT GAS STOVE

GET THE BEST VANTAGE.

Every angle gives you a beautiful view of the flames with the **VANTAGE** by Marquis.

This contemporary take on a classic wood stove adds warmth with a sleek charcoal finish and flat black accent. Amp up the impact with your choice of log sets, decorative stones, rocks, and cannonballs or even ember glass.



View the full Vantage brochure here.

VANTAGE (MQFDV453NE2)

F450FBL Door Front (Charcoal with Black Posts)

MQ453SDBL Door Sides (Solid Charcoal Panel with Black Frame)

ML0GF453 Log Set (Driftwood)

MQ453RLH Liner (Herringbone Brick)



VANTAGE (MQFDV453NE2)

F450FBL Door Front (Charcoal with Black Posts)

MQ453SDBL Door Sides (Solid Charcoal Panel with Black Frame)

MQG5C Glass Media (Bronze)

MQ453PL Liner (Porcelain Reflective)



VANTAGE

VANTAGE (MOFDV453NE2)

F450FBL Door Front (Charcoal with Black Posts)
MQ453SDBL Door Sides (Solid Charcoal Panel with Black Frame)
MQLOGF452 Log Set (Oak)
MQ453RLH Liner (Herringbone Brick)



VANTAGE (FDV451NE2)
F450FBL Door Front (Charcoal with Black Posts)
F451SDSBL Door Sides (Solid Charcoal Panel with Black Frame)
MQG5C Glass Media (Bronze)
MQROCK3 Rock Set (Multi-Colored)
F451RLT Liner (Traditional Brick)



VANTAGE (FDV451NE2)
F450FBL Door Front (Charcoal with Black Posts)
F451SDSBL Door Sides (Solid Charcoal Panel with Black Frame)
MQG5C Glass Media (Bronze)
RBCB1 Stone Media (Cannonballs)
F45LG Log Grate



VANTAGE (MOFDV453NE2)
F450FBL Door Front (Charcoal with Black Posts)
MQ453SDBL Door Sides (Solid Charcoal Panel with Black Frame)
MQG5C Glass Media (Bronze)
MQSTONE Stone Media (Decorative)
MQ451RLH Liner (Herringbone Brick)

LOG SETS



LOGF451 – Oak



MQLOGF452 – Oak



MQLOGF453 – Dirftwood

GLASS AND STONE MEDIA OPTIONS



MQG5ZG – Zircon Glacier Ice Glass



MQG5A – Cobalt Ember Glass



MQG5B – Black Ember Glass



MQG5C – Bronze Ember Glass



MQG5W – White Ember Glass



MQEMBER – Ember Chunks



MQSTONE – Decorative Stones



MQROCK2 – Natural Rocks



RBCB1 – Multi-Colored Cannonballs

LINERS



RLT – Traditional Brick



RLH – Herringbone Brick

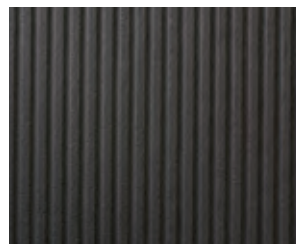

RLF – Fluted



PL – Porcelain Reflective

DIMENSIONS AND SIZING

FREE STANDING STOVES

SENTINEL

FRONT

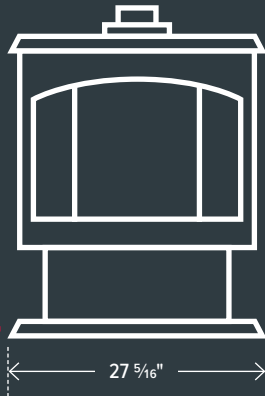

SIDE

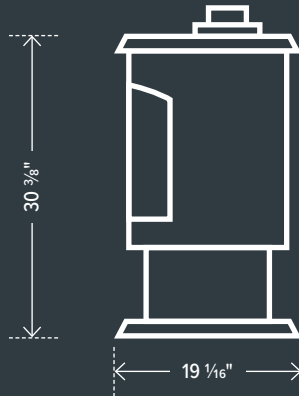

TITAN

FRONT

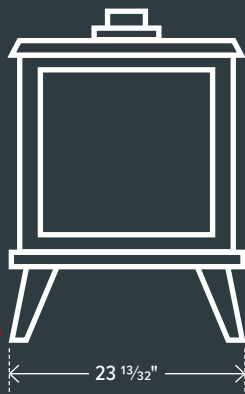

SIDE

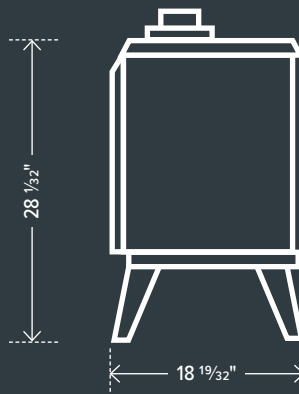

VANTAGE

FRONT

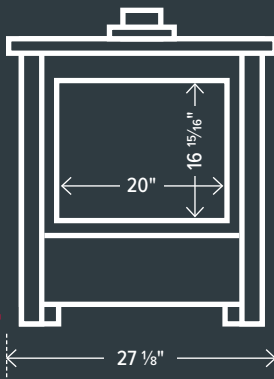

SIDE

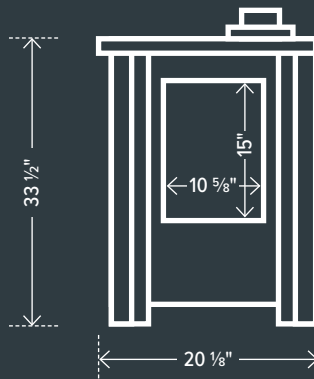

INSERTS



CAPELLA 26

DIRECT VENT GAS FIREPLACE INSERT

UPDATE YOUR NATURAL BEAUTY.

Transform your existing wood burning fireplace into an updated focal point with the **CAPELLA** insert. Beautifully crafted, the Capella features the expansive Clean View and adapts easily to your style.



View the full Capella brochure here.

CAPELLA 26 (IDV26NE2)

I26CV2BL Clean View (Black)
MQR0CK3 Stone Media (Multi-Colored Rocks)
MQRSP4 Rock Support Platform
IDV26PRL Liner (Porcelain Reflective)

CAPELLA 26 (IDV26NE2)
I26CV1BL Clean View (Black)
MOL0GF26 Log Set (Split Oak)
I26S1BL Surround (Black)
IDV26RL Liner (Traditional Brick)





CAPELLA 26

CAPELLA 26 (IDV26NE2)

I26CVPF2BL Clean View (Picture Frame – Black)
MQLOGF26 Log Set (Split Oak)
IDV26RL Liner (Traditional Brick)



CAPELLA 26 (IDV26NE2)

I26CV3BL Clean View (Black)
MQLOGF26 Log Set (Split Oak)
IDV26RL Liner (Traditional Brick)



CAPELLA 26 (IDV26NE2)

I26CV1BL Clean View (Black)
MQLOGF26 Log Set (Split Oak)
I26S1BL Surround (Black)
IDV26RL Liner (Traditional Brick)



CAPELLA 26 (IDV26NE2)

I26CV1BL Clean View (Black)
MQRSP8 Glass Support Platform
MQG5A Ember Glass (Cobalt)
IDV26PRL Liner (Porcelain Reflective)



LOG SETS



MQLOGF26 – Split Oak



LOGF27 – Split Oak

GLASS AND STONE MEDIA OPTIONS*



MQG5ZG – Zircon Glacier Ice Glass



MQG5A – Cobalt Ember Glass



MQG5B – Black Ember Glass



MQG5C – Bronze Ember Glass

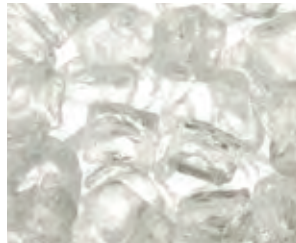

MQG5W – White Ember Glass



MQEMBER – Ember Chunks



MQSTONE – Decorative Stones



MQROCK2 – Natural Rocks

**Glass Tray or Rock Support Platform Required*

LINERS



RLT – Traditional Brick



PL – Porcelain Reflective

CAPRI 24/34/44

DIRECT VENT GAS FIREPLACE INSERT – FLUSH MOUNT SERIES

INSERT YOUR STYLE HERE.

The **CAPRI** Insert is a wonder, able to transform an existing wood burning fireplace into an updated focal point in any room. This Flush Mount Series is available in three sizes and your choice of liner, driftwood, oak or birch log set, decorative stone, or five different colors of crushed glass media.

With so many options, you'll find the Capri is perfectly attuned to your décor vision.



View the full Capri brochure here.

CAPRI 24

BOTTOM LEFT

CAPRI 24 (IDV24NE2)
I24CV1BL Clean View (Black)
MQL0GF24DW Log Set (Driftwood)



CAPRI 24 (IDV24NE2)
MQG5W Glass Media (White)



CAPRI 24 (IDV24NE2)
MQG5W Glass Media (White)
RBCB1 Stone Media (Cannonballs)



CAPRI 24 (IDV24NE2)
MQG5W Glass Media (White)
MQSTONES Stone Media (Decorative)

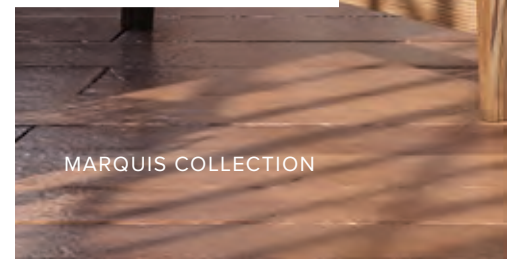

BELOW

CAPRI 24 (IDV24NE2)
I24CV1BL Clean View (Black)
LOGF24OAK Log Set (Split Oak)
IDV24RLT Liner (Traditional Brick)
I24SPF3829 Surround (Picture Frame)



CAPRI 34

CAPRI 34 (IDV34NE2)
I34CV1BL Clean View (Black)
MQSTONE Stone Media (Decorative)
MQRSP8 Glass Support Platform



CAPRI 34 (IDV34NE2)
 MQ34CV3BL Clean View (Black)
 MQ34DD1BL Designer Door (Series 1)
 MQLOGF34 Log Set (Split Oak)
 IDV33RL Liner (Traditional Brick)







CAPRI 34 (IDV34NE2)
 MQ34CV3BL Clean View (Black)
 MQ34DD1BL Designer Door (Black)
 I34S3927BL Surround (Black)
 MORBRW Log Set (Birchwood)
 MQRSP11 Support Platform
 MQG5C Glass Media (Bronze)
 IDV33PRL Liner (Porcelain Reflective)



CAPRI 34 (IDV34NE2)
 MQ34CV4PFBL Clean View (Picture Frame, Black)
 MQ34SF1BL Door Frame (Black)
 MQRSP8 Glass Support Platform
 MQG5A Ember Glass (Cobalt Blue)
 IDV33PRL Liner (Porcelain Reflective)



CAPRI 34 (IDV34NE2)
 MQ34CV3BL Clean View (Black)
 MQ34SF1BL Door Frame (Black)
 MQRBD4 Log Set (Driftwood)
 MQRSP11 Support Platform
 MQG5C Ember Glass (Bronze)
 IDV33PRL Liner (Porcelain Reflective)



CAPRI 34 (IDV34PE2)
 I34CV6BL Clean View with Backer Surround (Black)
 LOGF35 Log Set (Split Oak)
 IDV33RL Liner (Traditional Brick)

CAPRI 44



CAPRI 44 (IDV44NE2)
MQ44CV2BL Clean View (Black)
LOGF36 Log Set (Split Oak)
IDV36RLT Liner (Traditional Brick)



CAPRI 44 (IDV44NE2)
MQ44CV3BL Clean View (Black)
MQ44SF1BL Door Frame (Black)
I44S4432BL Surround (Black)
MQRSP11 Support Platform
MQLOGF453 Log Set (Driftwood)
IDV36RLT Liner (Traditional Brick)



CAPRI 44 (IDV44NE2)
LOGF36 Log Set (Split Oak)
IDV36RLH Liner (Herringbone Brick)

CAPRI 34/44 > ACCESSORIES

LOG SETS



MQLOGF34 – Split Oak
IDV34 / 44



LOGF35 – Split Oak
IDV34



LOGF36 – Split Oak
IDV44



MQLOGF33/453 – Driftwood
MQRSP11 REQUIRED



MQRBD4 – Driftwood
MQRSP11 & 15 LBS GLASS MEDIA REQUIRED



MQRBRW – Birchwood
MQRSP11 & 15 LBS GLASS MEDIA REQUIRED

GLASS AND STONE MEDIA OPTIONS*



MQG5ZG – Zircon Glacier Ice Glass



MQG5A – Cobalt Ember Glass

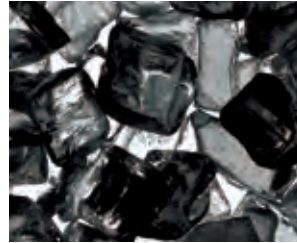

MQG5B – Black Ember Glass



MQG5C – Bronze Ember Glass

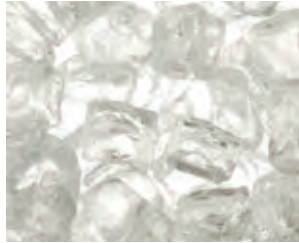

MQG5W – White Ember Glass



MQEMBER – Ember Chunks



MQSTONE – Decorative Stones



MQSTONE10 – Decorative Stones



MQROCK2 – Natural Rocks

**Glass Support Platform (MQRSP8) or Rock Support Platform (MQRSP4) Required*

LINERS



RLT – Traditional Brick
CAPRI 34/44



RLH – Herringbone Brick
CAPRI 44



RLF – Fluted
CAPRI 34/44



PL – Porcelain Reflective
CAPRI 34/44

DESIGNER DOORS AND FRAMES*



Designer Frame



DD1 – Series 1

**Required for MQ34CV3, MQ34CV4PF and MQ44CV3*

DIMENSIONS

INSERTS

MINIMUM FIREPLACE OPENING

CAPELLA 26

COMPONENTS IN

COMPONENTS OUT

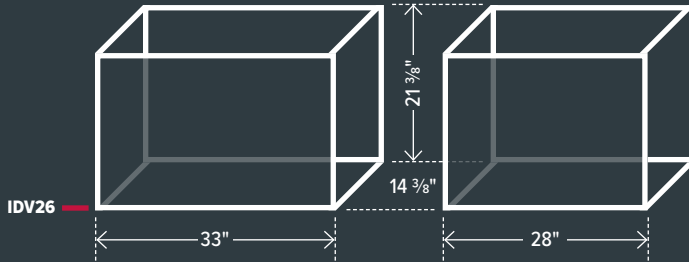

VIEWING AREA

CAPELLA 26

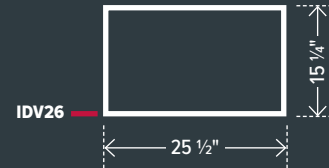

CAPRI 24/34/44

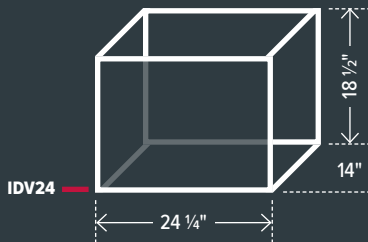

CAPRI 24/34/44

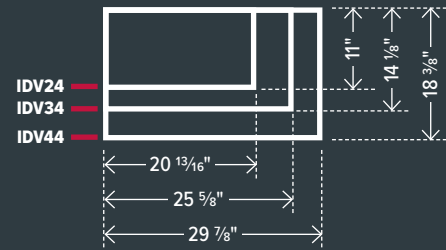

I34CV6BL

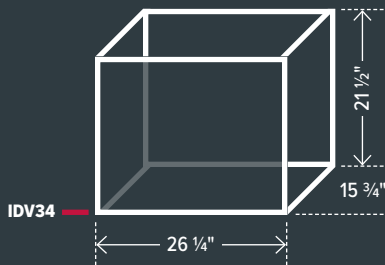

I34CV1 / MQ34CV2 / MQ34CV3 / MQ34CV4PF

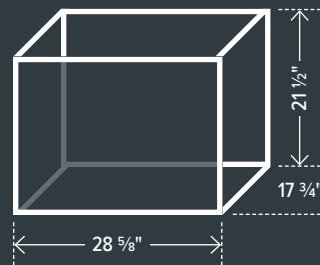

I44CV1 / MQ44CV2 / MQ44CV3

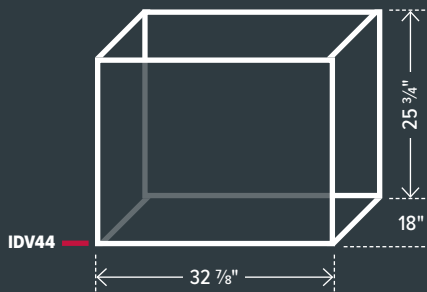

MULTI-SIDED FIREPLACES



ATRIUM

ZERO CLEARANCE DIRECT VENT GAS FIREPLACE

LOOK GREAT FROM EVERY ANGLE.

When the view is this good, you want to be able to see it from every angle. That's why the **ATRIUM** is an ideal 3-sided designer option to divide entertaining areas and create maximum impact and warmth.

Our Peninsula can be customized with your choice of brick liner, driftwood, logs, ember glass or rocks.



View the full Atrium brochure here.



BOTTOM LEFT

ATRIUM (MCVP42NH) – PENINSULA

MQG5C Ember Glass (Bronze)

MP42GT Glass Tray

MQ42LOG1 Log Set (Driftwood)

MP42PL Liner (Porcelain Reflective)



BELOW

ATRIUM (MCVP42NH) – PENINSULA
MQ42LOG2 Log Set (Oak)
M42LG Log Grate
MP42RLT Liner (Traditional Brick)





ATRIUM (MCVP42NHE) – PENINSULA
 MCVP42NHE Peninsula Fireplace (Natural Gas)
 M42LG Log Grate
 MQRBRW Log Set (Birch x2)
 MP42RLT Liner (Traditional Brick)



ATRIUM (MCVP42NH) – PENINSULA
 MQG5ZG Ember Glass (Zircon Ice)
 MP42GT Glass Tray
 MP42PL Liner (Porcelain Reflective)



ATRIUM (MCVP42NH) – PENINSULA
 MQG5C Ember Glass (Bronze)
 MP42GT Glass Tray
 MQSTONE Decorative Stones
 MP42PL Liner (Porcelain Reflective)



ATRIUM (MCVP42NH) – PENINSULA
 MQG5C Ember Glass (Bronze)
 MP42GT Glass Tray
 MQROCK2 Stone Media (Natural Rocks)
 MP42PL Liner (Porcelain Reflective)

LOG SETS*



MQ42LOG4 – Oak (8 piece)



MQ42LOG2 – Oak (7 piece)



M42LOG3 – Driftwood (6 piece)



MQ42LOG1 – Driftwood (8 piece)



MQRBRW – Birchwood

**Log Grate Required*

LINERS



RLT – Traditional Brick



PL – Porcelain Reflective

GLASS AND STONE MEDIA OPTIONS*



MQG5ZG – Zircon Glacier Ice Glass



MQG5A – Cobalt Ember Glass

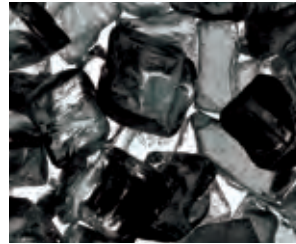

MQG5B – Black Ember Glass



MQG5C – Bronze Ember Glass



MQG5W – White Ember Glass



MQEMBER – Ember Chunks



MQSTONE – Decorative Stones



MQROCK2 – Natural Rocks



RBCB1 – Multi-Colored Cannonballs

**Glass Tray Required*

BENTLEY ST

ZERO CLEARANCE DIRECT VENT GAS FIREPLACE

TWO SIDES TO THIS STORY.

With an expansive glass viewing area and clever designer options, we thought the Bentley was pure designer perfection. Now, we've introduced the see-through **BENTLEY ST** which means you get the same view... twice!

Being able to enjoy the beauty and warmth from both sides means we've doubled the reasons to love the Bentley ST.



View the full Bentley ST brochure here.

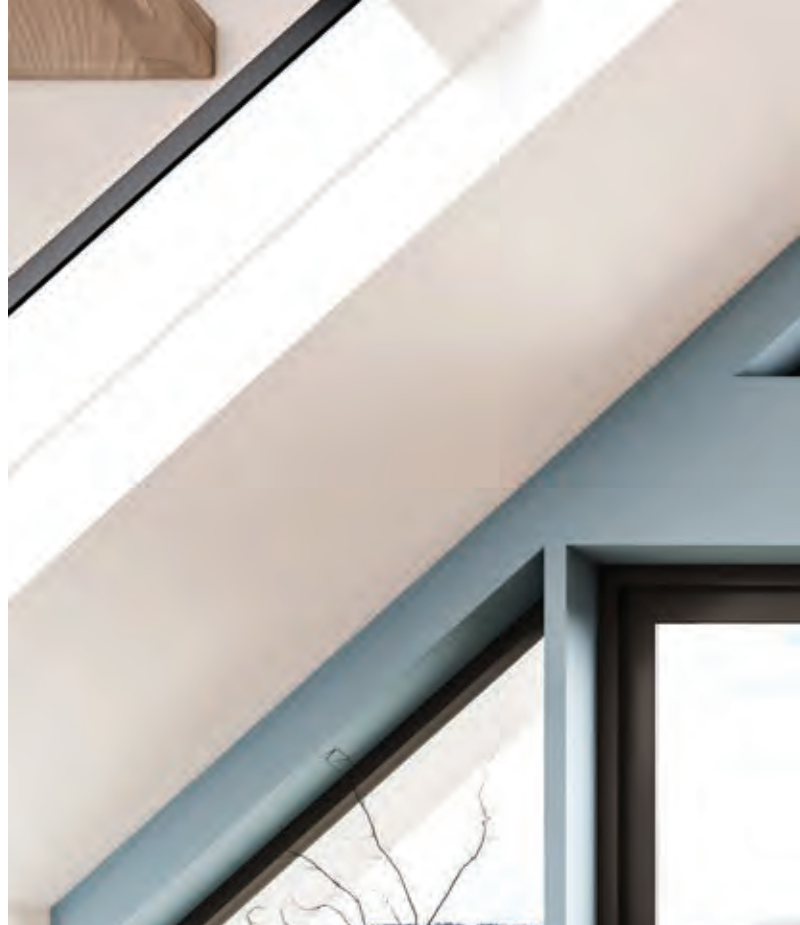

LEFT

BENTLEY ST (MCSVST42NH)
MQG5C Ember Glass (Bronze)
MST42GT Glass Tray
MQ42LOG3 Log Set (Driftwood)
MQ42DD2BL Designer Door (Series 2)



MULTI-SIDED FIREPLACES

BENTLEY ST (MCVST42NH)
MQG5C Ember Glass (Bronze)
MST42GT Glass Tray
ZCV42S1PFBL Surround (Picture Frame 4" Wide)
MST42PL Liner (Porcelain Reflective)



BENTLEY ST



BENTLEY ST (MCVST42NHE)
MQ42DD3BL Designer Door (Series 3)
M42LG Log Grate
MQRBRW Log Set (Birch x2)
MP42RLT Liner (Traditional Brick)



BENTLEY ST (MCVST42NH)
 ZCV42S1BL Surround (Hearth Mount 4" Wide)
 MST42GT Glass Tray
 MQG5C Ember Glass (Bronze)
 MQROCK2 Rock Set (Natural)
 MST42PL Liner (Porcelain Reflective)



BENTLEY ST (MCVST42NH)
 ZCV42S1PFBL Surround (Picture Frame 4" Wide)
 MST42GT Glass Tray
 MQG5C Ember Glass (Bronze)
 MQ42LOG1 Log Set (Driftwood)
 MST42PL Liner (Porcelain Reflective)



BENTLEY ST (MCVST42NH)
 ZCV42S2PFBL Surround (Picture Frame 1 5/8" Wide)
 MST42GT Glass Tray
 MQG5ZG Ember Glass (Zircon Ice)
 MQ42LOG1 Log Set (Driftwood)
 MST42PL Liner (Porcelain Reflective)

BENTLEY ST

BENTLEY ST (MCVST42NH)
MST42GT Glass Tray
MQG5C Ember Glass (Bronze)
MQSTONE Stone Media (Decorative)
MST42PL Liner (Porcelain Reflective)



BENTLEY ST > ACCESSORIES

LOG SETS



M42LOG4 – Oak



MQ42LOG2 – Oak



M42LOG3 – Driftwood



MQ42LOG1 – Driftwood



MQRBRW (2 piece) Birch Set



BENTLEY ST (MCVST42NH)
M42LG Log Grate
MQ42LOG2 Log Set (Oak)
MST42RLT Liner (Traditional Brick)
MQ42DD2BL Designer Door (Series 2)



GLASS AND STONE MEDIA OPTIONS*

**Glass Tray Required*



MQG5ZG – Zircon Glacier Ice Glass



MQG5A – Cobalt Ember Glass

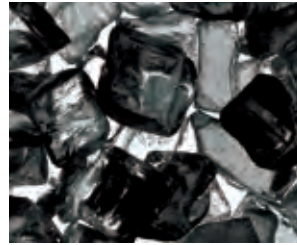

MQG5B – Black Ember Glass



MQG5C – Bronze Ember Glass

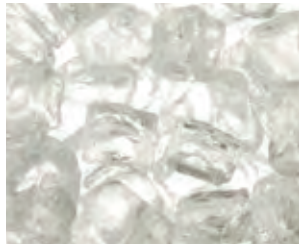

MQG5W – White Ember Glass



MQEMBER – Ember Chunks



MQSTONE – Decorative Stones



MQROCK2 – Natural Rocks



RBCB1 – Multi-Colored Cannonballs

DESIGNER DOORS



DD1 – Series 1



DD2 – Series 2



DD3 – Series 3 (Arched)

WALL SURROUNDS



Black – 4" Width



Black – 1 5/8" Width

LINERS



RLT – Traditional Brick



PL – Porcelain Reflective

ENCLAVE

ZERO CLEARANCE DIRECT VENT BAY PENINSULA
GAS FIREPLACE

CREATING A NEW DIMENSION.

Its wraparound view captivates from every angle. Luring you in with its three-dimensional sightlines, the **ENCLAVE** from Marquis creates a sleek and cleverly designed gathering point for the heart of your home.

Amazingly versatile, this beguiling fireplace adapts to suit any room with options for a Single Side, Corner or a Bay Peninsula. It transforms completely with your choice of fireplace liner and accessories that range from driftwood logs and contemporary rocks to cannonballs and glass.

With the ENCLAVE'S innovative vented chase technology you may now cover the fireplace with combustible materials up to the glass door opening.



View the full Enclave brochure here.

BOTTOM LEFT

ENCLAVE 48 (MOVLBG48NE2)

VL48EG Grill Kit (for Enclosure)
MQG5C Ember Glass (Bronze)
MQRBRW Log Set (Birchwood)
MQSTONE10 Stone Media (Decorative)
MQVL48RGB Back Liner (Reflective Glass)



BELOW

ENCLAVE 60 (MOVLBG60NE2)

MQG5C Ember Glass (Bronze)

MQVL60RGB Back Liner (Reflective Glass)





ENCLAVE 34 (MQZCVBG34NE2)
VL34EG Grill Kit (for Enclosure)
MQL0GF453 Log Set (Driftwood)
MQZCVBG34RGB Back Liner (Reflective Glass)



MULTI-SIDED FIREPLACES

ENCLAVE 34 (MQZCVBG34NE2)
MQL0GF34BW Log Set (Birchwood)
MQZCVBG34RGB Back Liner (Reflective Glass)



ENCLAVE 48 (MOVLBG48NE2)
VLBGCK Corner Kit
MQG5C Ember Glass (Bronze)
MQSTONE Stone Media (Decorative)
MQVL48RGE End Liners (Reflective Glass)



ENCLAVE 48 (MQVL48NE2)
 VL48EG Grill Kit (for Enclosure)
 MQG5W Ember Glass (White)
 MQVL48RGB Back Liner (Reflective Glass)
 MQVL48RGE End Liners (Reflective Glass)
 MQVL48S1BL Surround (Black).



ENCLAVE 48 (MQVLBG48NE2)
 VLBGCK Corner Kit, MQG5C Ember Glass (Bronze), MQRBD3 Log Set (Driftwood)



ENCLAVE 48 (MQVLBG48NE2)
 VLBGCK Corner Kit, MQG5C Ember Glass (Bronze), MQ46D Log Set (Driftwood),
 MQVL48RGB Back Liner (Reflective Glass)



ENCLAVE 48 (MQVLBG48NE2)
 MQG5C Ember Glass (Bronze), MQVL48RLFB2 Back Liner (Fluted Brick)

ENCLAVE 60



ENCLAVE 60 (MQVLBG60NE2)
MQG5C Ember Glass (Bronze), MQLOGF48D Log Set (Driftwood), MQSTONE10 Stone Media (Decorative), MQVL60RLSB Liner (Stacked Brick)



ENCLAVE 60 (MQVLBG60NE2)
MQG5C Ember Glass (Bronze), MQVL60RBRG Liner (Reflective Glass)



ENCLAVE 60 (MQVLBG60NE2)
MQG5C Ember Glass Media (Bronze), MQRBD3 Log Set (Driftwood), MQSTONE10 Stone Media (Decorative), MQVL60RLSB Liner (Stacked Brick)

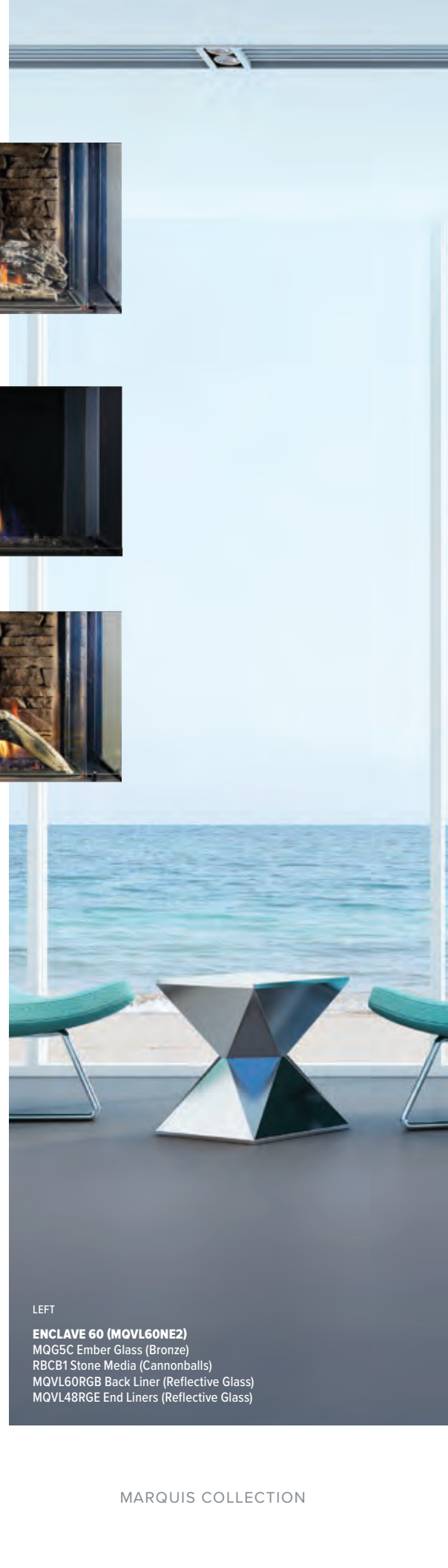

LEFT

ENCLAVE 60 (MQVL60NE2)
MQG5C Ember Glass (Bronze)
RBCB1 Stone Media (Cannonballs)
MQVL60RGRB Back Liner (Reflective Glass)
MQVL48RGE End Liners (Reflective Glass)

ENCLAVE 60 (MQVLBG60NE2)
VL60EG Grill Kit (for Enclosure)
MQG5C Ember Glass (Bronze)
MQVL60RLSB Liner (Stacked Brick)



ENCLAVE 72



ENCLAVE 72 (MQVLBG72NE2)
MQG5W Ember Glass (White), MQVL72RGB Back Liner (Reflective Glass)



ENCLAVE 72 (MQVL72NE2)
MQG5A Ember Glass (Cobalt), MQVL72RGB Back Liner (Reflective Glass)



ENCLAVE 72 (MQVLBG72NE2)
MQG5C Ember Glass (Bronze), MQLOGF48D Log Set (Driftwood), MQSTONE10 Stone Media (Decorative), MQVL72RGB Back Liner (Reflective Glass)



ENCLAVE 72 (MQVL72NE2)
MQG5A Ember Glass (Cobalt)
VL72S1SS Surround (Stainless Steel)
MQVL72RGB Back Liner (Reflective Glass)
VL72EG Front Enclosure Grills





ENCLAVE 72 (MOVLBG72NE2)
MQG5W Ember Glass (White)
MQLOGF48D Log Set (Driftwood)
MQSTONE10 Stone Media (Decorative)
MQVL72RGB Back Liner (Reflective Glass)

LOG SETS



MQLOGF34OAK – Oak
ENCLAVE 34



MQLOGF34BW – Birchwood
ENCLAVE 34



MQ42D – Driftwood
ENCLAVE 34



MQLOGF453 – Driftwood
ENCLAVE 34



MQ46D – Driftwood
ENCLAVE 48 / 60 / 72



MQRBD1 – Driftwood with Rocks
ENCLAVE 48 / 60 / 72



MQRBD4 (3-piece) / MQRBD3 (5-piece) – Driftwood
ENCLAVE 34 / 48 / 60 / 72



MQLOGF48D – Driftwood*
ENCLAVE 48 / 60 / 72



MQRBD2 – Driftwood
ENCLAVE 48 / 60 / 72



MQRBRW – Birchwood
ENCLAVE 34 / 48 / 60 / 72

LINERS



RLT – Traditional Brick
ENCLAVE 34



RLF – Fluted
ENCLAVE 34 / 48 / 60 / 72



RLS – Stacked Brick
ENCLAVE 48 / 60 / 72



GL – Glass Reflective
ENCLAVE 34 / 48 / 60 / 72

GLASS AND STONE MEDIA OPTIONS



MQG5ZG – Zircon Glacier Ice Glass



MQG5A – Cobalt Ember Glass



MQG5B – Black Ember Glass



MQG5C – Bronze Ember Glass

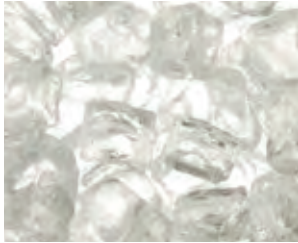

MQG5W – White Ember Glass



MQEMBER – Ember Chunks



MQSTONE – Decorative Stones



MQROCK2 – Natural Rocks



RBCB1 – Multi-Colored Cannonballs

INFINITE

ZERO CLEARANCE DIRECT VENT GAS FIREPLACE

INFINITE POSSIBILITIES.

A fabulously sleek stretch of dancing flames delivers **INFINITE** possibilities in this modern zero clearance gas fireplace by Marquis.



View the full Infinite brochure here.



BOTTOM LEFT

INFINITE (MORB6961NE2)

MORB69BK Back Shield Kit (for Single-Sided Viewing)

MQRBD2 Log Set (Driftwood)

MQROCK3 Rock Set (Multi-Colored)

MQEMBER Stone Media (Ember Chunks)



BELOW

INFINITE (MORB4436NE2)

MORB44BK Back Shield Kit (for Single-Sided Viewing)

MORB4436PLB Back Liner (Porcelain Reflective)

MORB5143PLE End Liners (Porcelain Reflective)



INFINITE



INFINITE (MORB5143NE2)
 MORB51BK Single Sided Kit
 MQRBRW Log Set (Birchwood)
 MORB5143PLB Back Liner (Porcelain Reflective)
 MORB5143PLE End Liners (Porcelain Reflective)
 MQRB5019SBL Surround (Edge Black)
 MQSTONE10 Stone Media (Decorative)

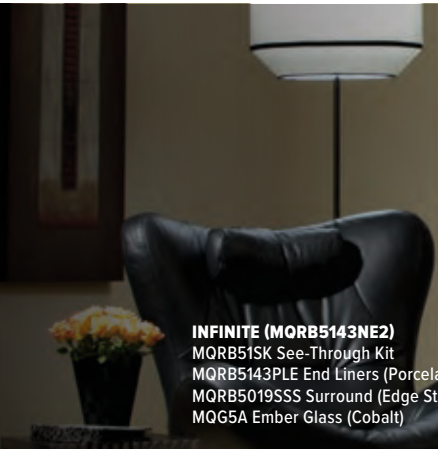

INFINITE (MORB5143NE2)
 MQRB51SK See-Through Kit
 MORB5143PLE End Liners (Porcelain Reflective)
 MQRB5019SSS Surround (Edge Stainless Steel)
 MQG5A Ember Glass (Cobalt)

INFINITE > ACCESSORIES

LOG SETS



MQ46D – Driftwood
 INFINITE 5143 / 6961



MQRBD1 – Driftwood with Rocks



MQRBD2 – Driftwood



MQRBD3 / MQRBD4 – Driftwood
 5 PIECE 3 PIECE



MQRBRW – Birchwood

GLASS AND STONE MEDIA OPTIONS



MQG5ZG – Zircon Glacier Ice Glass



MQG5A – Cobalt Ember Glass



MQG5B – Black Ember Glass



MQG5C – Bronze Ember Glass

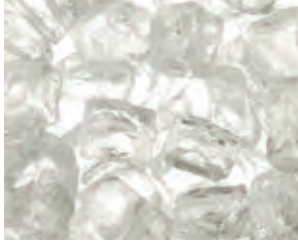

MQG5W – White Ember Glass



MQEMBER – Ember Chunks



MQSTONE – Decorative Stones



MQROCK2 – Natural Rocks



RBCB1 – Multi-Colored Cannonballs

LINERS



RLF – Fluted
SINGLE SIDED MODELS ONLY



PL – Porcelain Reflective

SURROUNDS



Black



Stainless Steel

VIEWING AREA DIMENSIONS

MULTI-SIDED FIREPLACES

ATRIUM

FRONT

SIDE



BENTLEY ST

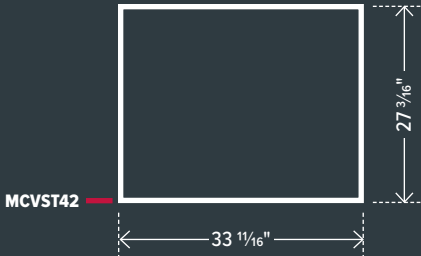

ENCLAVE

FRONT

SIDE

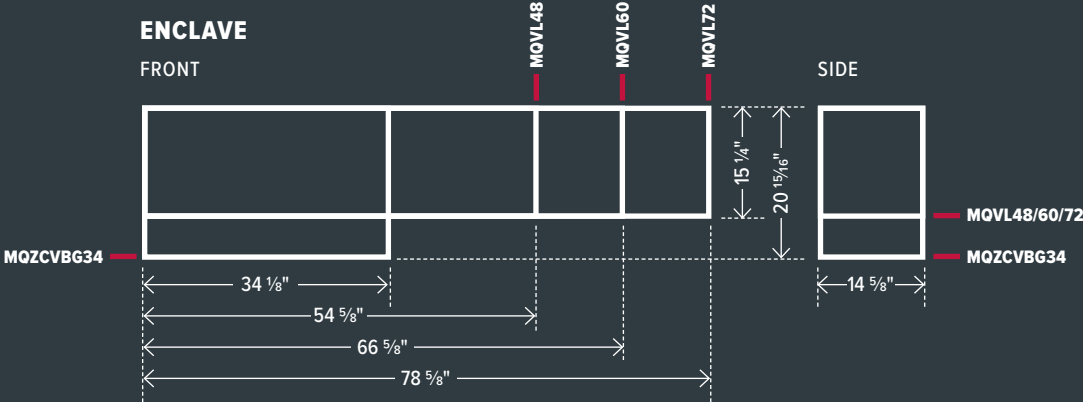

INFINITE

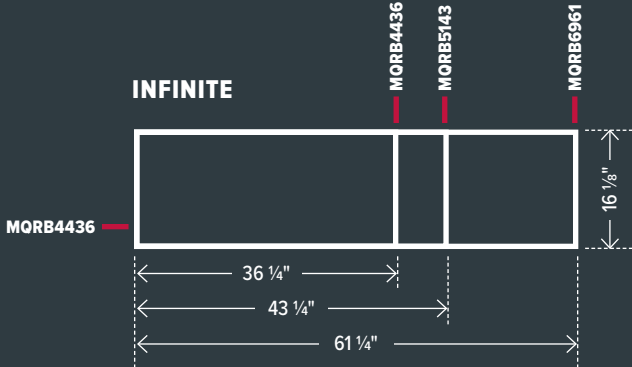

OUTDOOR LIVING



AURORA

ZERO CLEARANCE OUTDOOR GAS FIREPLACE

AURORA (OFP42NS)
MQG5W Ember Glass (White)
MQROCK2 Rocks (Natural)

LIGHT UP YOUR NIGHTS.

Nights will never be the same with the **AURORA**. Designed for your outdoor oasis, this fireplace captures your attention with its satin coat black or stainless steel finish and your choice of brick liner, contemporary rock collection or stones, five options of glass media or log set... Looks like the stars in the sky now have a little competition.



View the full Aurora brochure here.



LOG SET



LOGF36 – Split Oak

TRIM



STAINLESS

LINERS



OFP42RLT – Traditional Brick



OFP42RLH – Herringbone Brick

GLASS AND STONE MEDIA OPTIONS



MQG5ZG – Zircon Glacier Ice Glass



MQG5A – Cobalt Ember Glass



MQG5B – Black Ember Glass



MQG5C – Bronze Ember Glass



MQG5W – White Ember Glass



MQSTONE – Decorative Stones



MQROCK2 – Natural Rocks



AURORA (OFP42NS)
LOGF36 Log Set (Split Oak)
OFP42RLT Liner (Traditional Brick)

BOLA

OUTDOOR GAS FIRE BOWL

TAKE COMFORT OUTDOORS.

The **BOLA** is perfect way to enhance the enjoyment of any outdoor space. Ideally suited for use on a wood deck or patio, the Bola comes complete with lava rock and is fuelled by either natural gas or propane. Decorate your BOLA with your choice of decorative stone, or five different colors of crushed glass media.



View the full Bola brochure here.

BOTTOM LEFT

BOLA (FP2085LPT)

FPB30SGT Concrete Fire Bowl (Smooth Grey)
MLR1410 Stone Media (Lava Rock)



BELOW

BOLA (FP2085LPT)

FPB30TBT Concrete Fire Bowl (Textured Charcoal)

MQG5A Ember Glass (Cobalt)



FP2085 ROUND FIRE PIT



ROUND FIRE PIT (FP2085LPT)
LOGC86 Log Set (Oak)

BOLA FP2085 > ACCESSORIES

OPTIONAL COVER



FP20COV – Table Top Cover
Conveniently covers up propane tank when fire pit is in use.

COMPONENTS



FP2085NT Round Outdoor Gas Fire Pit with MQSTONE Stone Media (Decorative)



FP2085NT Round Outdoor Gas Fire Pit with FP20SSRT Stainless Steel Ring

FP2785 RECTANGULAR FIRE PIT



RECTANGULAR FIRE PIT (FP2785LPT-FL)
LOGC85 Log Set (Oak)

BOLA FP2785 > ACCESSORIES

OPTIONAL COVER



FP27COV – Fire Pit Cover



LOG SETS



LOGC85 – Oak



LOGC86 – Oak

LOG SETS



LOGC85 – Oak



LOGC86 – Oak

BOLA COLOURS



Textured Charcoal

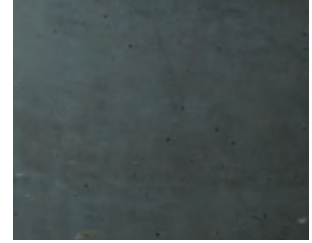

Smooth Grey

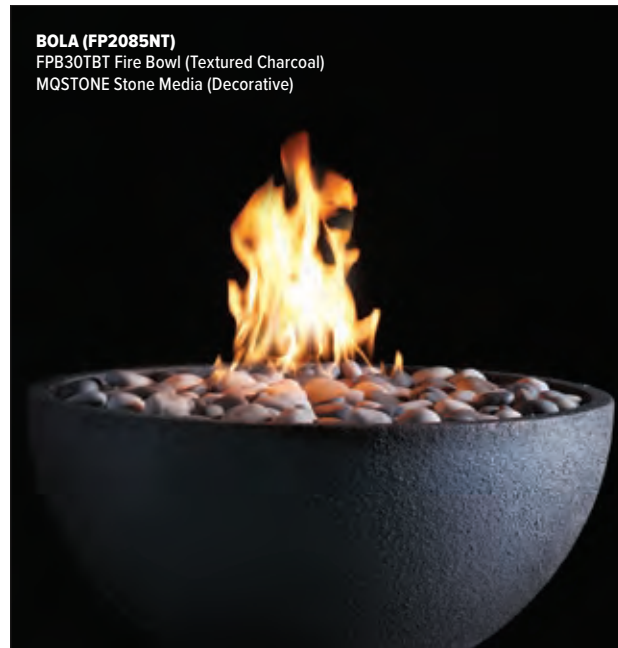

BOLA (FP2085NT)
FPB30TBT Fire Bowl (Textured Charcoal)
MQSTONE Stone Media (Decorative)

GLASS AND STONE MEDIA OPTIONS



MQG5ZG – Zircon Glacier Ice Glass



MQG5A – Cobalt Ember Glass

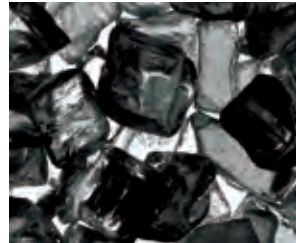

MQG5B – Black Ember Glass



MQG5C – Bronze Ember Glass

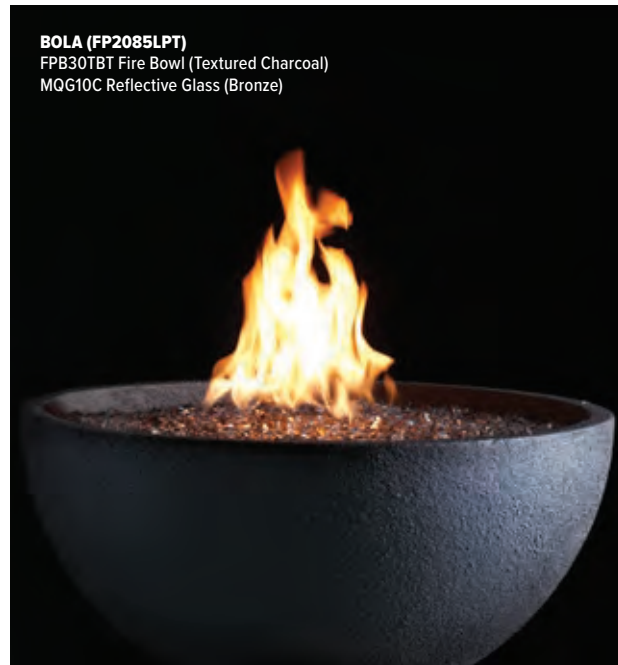

BOLA (FP2085LPT)
FPB30TBT Fire Bowl (Textured Charcoal)
MQG10C Reflective Glass (Bronze)



MQG5W – White Ember Glass



MQSTONE – Decorative Stones

BOLA COVER



FPB30COVB – Bola Cover

TRIM RING



FPB32TRG – Trim Ring

VIEWING AREA DIMENSIONS

OUTDOOR LIVING

AURORA

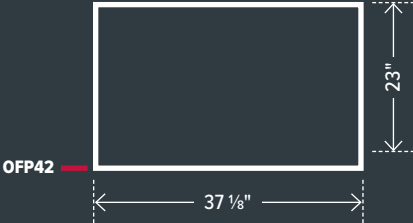

BOLA

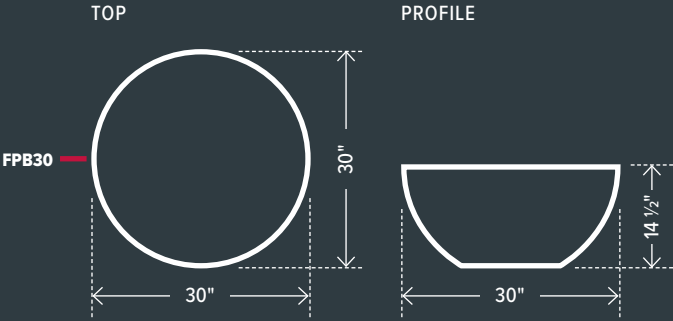
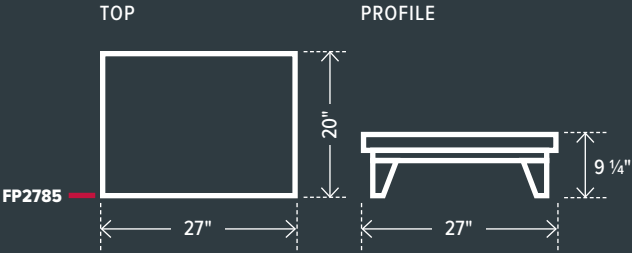
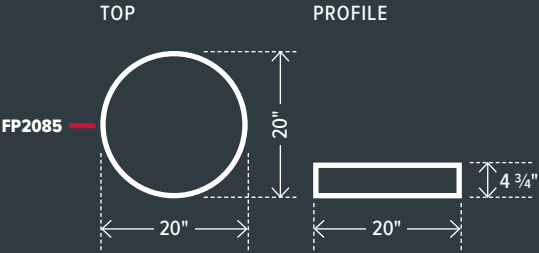

STYLING OPTIONS



LOG SETS



View the full Marquis Flame Gallery here.



LOGC85 – Split Oak (4 pc)



LOGC86 – Oak



LOGF3 – Split Oak (5 pc)



LOGF26 – Fibre Split Oak



LOGF27 – Fibre Split Oak



LOGF35 – Fibre Split Oak



LOGF36 – Fibre Split Oak



LOGF200 – Split Oak



LOGF452 – Oak



M42LOG3 – Driftwood



M42LOG4 – Oak



MQ42LOG1 – Oak Driftwood (8 pc)



MQLOG48D – Driftwood (6 pc)



MQ39D – Driftwood (4 pc)



MQ42D – Driftwood (6 pc)



MQ46D – Driftwood (3 pc)



MQLOGC22 – Split Oak



MQLOGC23 – Driftwood



MQLOGC45 – Burnt Oak



MQLOGF9 – Split Oak (10 pc)



MQLOGF33 – Driftwood



MQLOGF34 – Fibre Split Oak



MQLOGF48 – Split Oak



MQLOGF48B – Split Oak



MQLOGF48D – Driftwood



MQLOGF453 – Driftwood



MQRBD1 – Driftwood (4 pc) with Rocks (4 pc)



MQRBD2 – Oak Driftwood (3 pc)



MQRBD3 – Driftwood (5 pc)



MQRBD4 – Driftwood (3 pc)



MQRBRW – Birchwood

ACCESSORIES GALLERY



View the full Marquis Accessories Gallery here.

GLASS AND STONE MEDIA OPTIONS



MQG5ZG – Zircon Glacier Ice Glass



MQG5A – Cobalt Ember Glass



MQG5B – Black Ember Glass



MQG5C – Bronze Ember Glass



MQG5W – White Ember Glass



MQEMBER – Ember Chunks



MQSTONE – Decorative Stones



RBCB1 – Multi-Colored Cannonballs



MQROCK2 – Natural Rocks



MLR1410 – Lava Rock

LINERS



RLT – Traditional Brick



RLH – Herringbone Brick

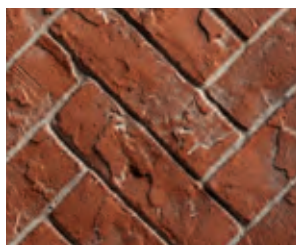

RRH – Red Herringbone Brick



RLS – Stacked Brick

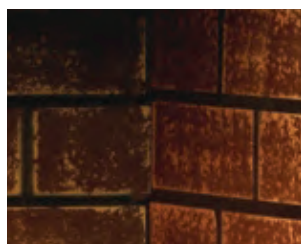

ML – Metal Brick

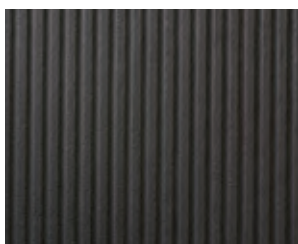

RLF – Fluted



PL – Porcelain Reflective



GL – Glass Reflective

REMOTE CONTROLS



PF1 IPI/MV



PF2 IPI



PF2 IPI

THERMOSTAT



Z80PT – Wall Mount

DESIGNER DOORS



DD1 – Series 1



DD2 – Series 2



DD3 – Series 3 (Arched)

WALL SURROUNDS



EDGE – Black



EDGE – Stainless Steel



FLATT – Black



HEARTH MOUNT – Black



FLATT – Black

FLAME CHART

To determine which Flame Display models accommodate your desired fireplace, please refer to the chart below.

MARQUIS COLLECTION MODELS

NAME	MODELS	Natural Rocks	Decorative Ember Glass	Decorative Stones	Contemporary Rocks and Driftwood Options	Glass or Rock Support Platform	Multi-Colored Cannonballs	LOG SETS		
								Oak Log Set	Driftwood Log Set	Birchwood Log Set
ATRIUM	MCVP42	•	•	•	•	•	•	•	•	•
AURORA	OFP42	•	•	•				•		
BOLA	FP2085	•	•	•				•		
	FP2785	•	•	•				•		
	FPB30	•	•	•				•		
BENTLEY	ZCV34	•	•	•	•	•	•	•	•	•
	ZCV39	•	•	•	•	•	•	•	•	•
	ZCV42	•	•	•	•	•	•	•	•	•
BENTLEY 48	MQZCV48	•	•	•	•	•	•	•	•	•
BENTLEY ST	MCVST42	•	•	•	•	•	•	•	•	•
CAPELLA	IDV26	•	•	•		•		•		
CAPRI	IDV24	•	•	•		•		•	•	
	IDV34	•	•	•		•		•	•	•
	IDV44	•	•	•		•		•	•	•
ENCLAVE	MQZCVBG34	•	•	•	•		•	•	•	•
	MQVL48	•	•	•	•		•	•	•	•
	MQVL60	•	•	•	•		•	•	•	•
	MQVLB72	•	•	•	•		•	•	•	•
INFINITE	MQRB4436	•	•	•	•		•	•	•	•
	MQRB5143	•	•	•	•		•	•	•	•
	MQRB6961	•	•	•	•		•	•	•	•
SENTINEL	FDV350							•		
SERENE	ZCVRB47	•	•	•	•		•	•	•	•
	ZCVRB60	•	•	•	•		•	•	•	•
	ZCVRB72	•	•	•	•		•	•	•	•
SKYLINE	ZCVRB3622	•	•	•	•		•	•		
	MQRB4236	•	•	•	•		•	•		
SOLACE	MQHBZDV3636	•				•		•		
	MQHBZDV4236	•				•		•		
	MQHBZDV4736	•				•		•		
SOLACE II	HBZDV3624	•				•		•		•
	HBZDV4224	•				•		•		•
SOLARA II	ZCV3622	•				•		•	•	
TITAN	FDV200							•		
VANTAGE	FDV451	•	•	•	•		•	•	•	•
	MQFDV453	•	•	•	•		•	•	•	•

PRODUCT SPECIFICATIONS

ATRIUM

MODELS >	MCVP42N/NE	MCVP42NH/NHE	MCVP42LP/LPE	MCVP42LPH/LPHE
FUEL	Natural Gas	Natural Gas	Propane	Propane
GAS CONTROL	Millivolt / IPI	Millivolt / IPI	Millivolt / IPI	Millivolt / IPI
INPUT MAX.	30,250 BTU	31,250 BTU	28,500 BTU	29,000 BTU
INPUT MIN.	21,000 BTU	21,250 BTU	23,000 BTU	23,000 BTU
FE (P.4.1-15)%	53.00% / 54.63%	64.55% / 66.49%	53.82% / 55.32%	65.66% / 67.42%
FLUE SIZES	5/8"	5/8"	5/8"	5/8"
GLASS TYPE	Tempered	Ceramic	Tempered	Ceramic
SIZE (W x H x D)	43 1/16" x 42 1/4" x 24 1/2"	43 1/16" x 42 1/4" x 24 1/2"	43 1/16" x 42 1/4" x 24 1/2"	43 1/16" x 42 1/4" x 24 1/2"
VIEWING AREA (W x H)	33 1/2" x 20 5/8"	33 1/2" x 20 5/8"	33 1/2" x 20 5/8"	33 1/2" x 20 5/8"

AURORA

	BLACK	STAINLESS	BLACK	STAINLESS
MODELS >	OFP42N/NE	OFP42NS/NSE	OFP42LP/LPE	OFP42LPS/LPSE
FUEL	Natural Gas	Natural Gas	Propane	Propane
GAS CONTROL	Millivolt	Millivolt	Millivolt	Millivolt
INPUT MAX.	55,000 BTU	55,000 BTU	55,000 BTU	55,000 BTU
INPUT MIN.	38,000 BTU	38,000 BTU	44,000 BTU	44,000 BTU
SIZE (W x H x D)	42" x 38 1/4" x 18 1/2"	42" x 38 1/4" x 18 1/2"	42" x 38 1/4" x 18 1/2"	42" x 38 1/4" x 18 1/2"
VIEWING AREA (W x H)	37 1/8" x 23"	37 1/8" x 23"	37 1/8" x 23"	37 1/8" x 23"

BOLA

MODELS >	FP2085NT	FP2085LPT	FP2785NT	FP2785LPT-FL
FUEL	Natural Gas	Propane	Natural Gas	Propane
GAS CONTROL	Manual	Manual	Manual	Manual
INPUT	57,000 BTUH	64,000 BTUH	57,000 BTUH	64,000 BTUH
SIZE	4 1/2"H x 20" Dia.	4 1/2"H x 20" Dia.	20"W x 9"H x 27"D	20"W x 9"H x 27"D
BOWL SIZE	14"H x 30" Dia.	14"H x 30" Dia.	-	-

BENTLEY 34

MODELS >	ZCV34N/NE/NE2	ZCV34NH/NHE/NHE2	ZCV34LP/LPE/LPE2	ZCV34LPH/LPHE/LPHE2
FUEL	Natural Gas	Natural Gas	Propane	Propane
GAS CONTROL	Millivolt / IPI	Millivolt / IPI	Millivolt / IPI	Millivolt / IPI
INPUT MAX.	19,000 BTU	19,000 BTU	18,000 BTU	18,000 BTU
INPUT MIN.	13,500 BTU	13,500 BTU	14,000 BTU	14,000 BTU
FE (P.4.1-15)%	53.49% / 56.14%	63.25% / 66.45%	58.67% / 61.17%	66.38% / 69.25%
FLUE SIZES	4/7"	4/7"	4/7"	4/7"
GLASS TYPE	Tempered	Ceramic	Tempered	Ceramic
SIZE (W x H x D)	33" x 36" x 18 1/16"	33" x 36" x 18 1/16"	33" x 36" x 18 1/16"	33" x 36" x 18 1/16"
VIEWING AREA (W x H)	28 5/8" x 25 3/8"	28 5/8" x 25 3/8"	28 5/8" x 25 3/8"	28 5/8" x 25 3/8"

BENTLEY 39

MODELS >	ZCV39N/NE/NE2	ZCV39NH/NHE/NHE2	ZCV39LP/LPE/LPE2	ZCV39LPH/LPHE/LPHE2
FUEL	Natural Gas	Natural Gas	Propane	Propane
GAS CONTROL	Millivolt / IPI	Millivolt / IPI	Millivolt / IPI	Millivolt / IPI
INPUT MAX.	25,000 BTU	28,000 BTU	25,000 BTU	29,000 BTU
INPUT MIN.	16,750 BTU	19,000 BTU	20,000 BTU	23,000 BTU
FE (P.4.1-15)%	52.35% / 54.24%	63.81% / 66.17%	52.35% / 54.24%	66.82% / 68.65%
FLUE SIZES	4/7"	4/7"	4/7"	4/7"
GLASS TYPE	Tempered	Ceramic	Tempered	Ceramic
SIZE (W x H x D)	39 3/8" x 37 1/16" x 18 7/16"	39 3/8" x 37 1/16" x 18 7/16"	39 3/8" x 37 1/16" x 18 7/16"	39 3/8" x 37 1/16" x 18 7/16"
VIEWING AREA (W x H)	33" x 28 5/8"	33" x 28 5/8"	33" x 28 5/8"	33" x 28 5/8"

BENTLEY 42

MODELS >	ZCV42N/NE/NE2	ZCV42NH/NHE/NHE2	ZCV42LP/LPE/LPE2	ZCV42LPH/LPHE/LPHE2
FUEL	Natural Gas	Natural Gas	Propane	Propane
GAS CONTROL	Millivolt / IPI	Millivolt / IPI	Millivolt / IPI	Millivolt / IPI
INPUT MAX.	25,000 BTU	29,500 BTU	25,000 BTU	29,000 BTU
INPUT MIN.	16,500 BTU	20,000 BTU	19,500 BTU	23,000 BTU
FE (P.4.1-15)%	52.86% / 54.95%	64.53% / 66.48%	52.86% / 54.95%	66.65% / 68.77%
FLUE SIZES	4/7"	4/7"	4/7"	4/7"
GLASS TYPE	Tempered	Ceramic	Tempered	Ceramic
SIZE (W x H x D)	42 7/16" x 40 7/8" x 18 7/16"	42 7/16" x 40 7/8" x 18 7/16"	42 7/16" x 40 7/8" x 18 7/16"	42 7/16" x 40 7/8" x 18 7/16"
VIEWING AREA (W x H)	37 1/8" x 31 3/4"	37 1/8" x 31 3/4"	37 1/8" x 31 3/4"	37 1/8" x 31 3/4"

BENTLEY 48

MODELS >	MQZCV48N	MQZCV48LP	MQZCV48NE/NE2	MQZCV48LPE/LPE2
FUEL	Natural Gas	Propane	Natural Gas	Propane
GAS CONTROL	Millivolt	Millivolt	IPI	IPI
INPUT MAX.	42,500 BTU	42,250 BTU	42,500 BTU	42,250 BTU
INPUT MIN.	28,500 BTU	34,000 BTU	28,500 BTU	34,000 BTU
FE (P.4.1-15)%	52.24%	54.52%	53.37%	55.71%
FLUE SIZES	5/8"	5/8"	5/8"	5/8"
GLASS TYPE	Tempered	Tempered	Tempered	Tempered
SIZE (W x H x D)	48 3/8" x 49 11/16" x 22 15/16"	48 3/8" x 49 11/16" x 22 15/16"	48 3/8" x 49 11/16" x 22 15/16"	48 3/8" x 49 11/16" x 22 15/16"
VIEWING AREA (W x H)	43" x 36 3/4"	43" x 36 3/4"	43" x 36 3/4"	43" x 36 3/4"

BENTLEY ST

MODELS >	MCVST42N/NE	MCVST42NH/NHE	MCVST42LP/LPE	MCVST42LPH/LPHE
FUEL	Natural Gas	Natural Gas	Propane	Propane
GAS CONTROL	Millivolt / IPI	Millivolt / IPI	Millivolt / IPI	Millivolt / IPI
INPUT MAX.	30,250 BTU	31,000 BTU	29,000 BTU	29,250 BTU
INPUT MIN.	20,750 BTU	21,000 BTU	23,000 BTU	23,000 BTU
FE (P.4.1-15)%	57.56% / 59.55%	66.45% / 68.58%	58.56% / 55.32%	67.88% / 70.36%
FLUE SIZES	5/8"	5/8"	5/8"	5/8"
GLASS TYPE	Tempered	Ceramic	Tempered	Ceramic
SIZE (W x H x D)	43 1/16" x 51 1/4" x 24 1/4"	43 1/16" x 51 1/4" x 24 1/4"	43 1/16" x 51 1/4" x 24 1/4"	43 1/16" x 51 1/4" x 24 1/4"
VIEWING AREA (W x H)	37 1/8" x 31 3/4"	37 1/8" x 31 3/4"	37 1/8" x 31 3/4"	37 1/8" x 31 3/4"

CAPELLA

MODELS >	IDV26N	IDV26NE2/NE	IDV26LP	IDV26LPE2/LPE
FUEL	Natural Gas	Natural Gas	Propane	Propane
GAS CONTROL	Millivolt	IPI	Millivolt	IPI
INPUT MAX.	30,000 BTU	30,000 BTU	30,000 BTU	30,000 BTU
INPUT MIN.	21,000 BTU	21,000 BTU	25,000 BTU	25,000 BTU
FE (P.4.1-15)%	65.25%	67.37%	66.30%	68.30%
FLUE SIZES	3/3"	3/3"	3/3"	3/3"
GLASS TYPE	Ceramic	Ceramic	Ceramic	Ceramic
SIZE (W x H x D)	28" x 19 1/2" x 14 1/4"	28" x 19 1/2" x 14 1/4"	28" x 19 1/2" x 14 1/4"	28" x 19 1/2" x 14 1/4"
VIEWING AREA (W x H)	25 1/2" x 15 1/4"	25 1/2" x 15 1/4"	25 1/2" x 15 1/4"	25 1/2" x 15 1/4"

CAPRI 24

MODELS >	IDV24N/NE/NE2	IDV24LP/LPE/LPE2
FUEL	Natural Gas	Propane
GAS CONTROL	Millivolt / IPI	Millivolt / IPI
INPUT MAX.	24,000 BTU	24,000 BTU
INPUT MIN.	16,750 BTU	20,000 BTU
FE (P.4.1-15)%	53.53% / 55.58%	57.51% / 59.24%
FLUE SIZES	3/3" or 2/3"*	3/3" or 2/3"*
GLASS TYPE	Ceramic	Ceramic
SIZE (W x H x D)	25 5/8" x 18 1/2" x 15"	25 5/8" x 18 1/2" x 15"
VIEWING AREA (W x H)	20 13/16" x 11"	20 13/16" x 11"

*2/3" venting limited to 25 ft. vertical

CAPRI 34

MODELS >	IDV34N/NE/NE2	IDV34LP/LPE/LPE2
FUEL	Natural Gas	Propane
GAS CONTROL	Millivolt / IPI	Millivolt / IPI
INPUT MAX.	31,000 BTU	28,500 BTU
INPUT MIN.	20,900 BTU	23,100 BTU
FE (P.4.1-15)%	62.86% / 64.73%	63.63% / 65.63%
FLUE SIZES	3/3"	3/3"
GLASS TYPE	Ceramic	Ceramic
SIZE (W x H x D)	28 5/8" x 21 3/8" x 18 1/4"	28 5/8" x 21 3/8" x 18 1/4"
VIEWING AREA (W x H)	25 5/8" x 14 1/8"	25 5/8" x 14 1/8"

CAPRI 44

MODELS >	IDV44N/NE/NE2	IDV44LP/LPE/LPE2
FUEL	Natural Gas	Propane
GAS CONTROL	Millivolt / IPI	Millivolt / IPI
INPUT MAX.	34,250 BTU	30,000 BTU
INPUT MIN.	24,000 BTU	22,840 BTU
FE (P.4.1-15)%	60.18% / 61.70%	60.18% / 61.85%
FLUE SIZES	4/3"	4/3"
GLASS TYPE	Ceramic	Ceramic
SIZE (W x H x D)	32 7/8" x 25 3/4" x 18 9/16"	32 7/8" x 25 3/4" x 18 9/16"
VIEWING AREA (W x H)	29 7/8" x 18 3/8"	29 7/8" x 18 3/8"

ENCLAVE 34

MODELS >	MQZCVBG34NE2	MQZCVBG34LPE2
FUEL	Natural Gas	Propane
GAS CONTROL	IPI PF2	IPI PF2
INPUT MAX.	25,000 BTU	24,000 BTU
INPUT MIN.	17,000 BTU	19,000 BTU
FE (P.4.1-15)%	52.94%	51.96%
FLUE SIZES	5"8"	5"8"
GLASS TYPE	Ceramic	Ceramic
SIZE (W x H x D)	34 5/16" x 37 5/8" x 16 7/16"	34 5/16" x 37 5/8" x 16 7/16"
VIEWING AREA (W x H)	34 1/8" x 20 15/16"	34 1/8" x 20 15/16"

ENCLAVE 48

MODELS >	MQVL48LPE2	MQVL48NE2	MQVLBG48LPE2	MQVLBG48NE2
FUEL	Propane	Natural Gas	Propane	Natural Gas
GAS CONTROL	IPI PF2	IPI PF2	IPI PF2	IPI PF2
INPUT MAX.	35,000 BTU	35,000 BTU	35,000 BTU	35,000 BTU
INPUT MIN.	27,000 BTU	25,000 BTU	27,000 BTU	25,000 BTU
FE (P.4.1-15)%	53.20%	53.20%	53.20%	53.20%
FLUE SIZES	5/8"	5/8"	5/8"	5/8"
GLASS TYPE	Ceramic	Ceramic	Ceramic	Ceramic
SIZE (W x H x D)	56 1/2" x 36 5/16" x 18 7/8"	56 1/2" x 36 5/16" x 18 7/8"	56 1/2" x 36 5/16" x 18 7/8"	56 1/2" x 36 5/16" x 18 7/8"
VIEWING AREA (W x H)	54 5/8" x 15 1/4"	54 5/8" x 15 1/4"	54 5/8" x 15 1/4"	54 5/8" x 15 1/4"

ENCLAVE 60

MODELS >	MQVL60LPE2	MQVL60NE2	MQVLBG60LPE2	MQVLBG60NE2
FUEL	Propane	Natural Gas	Propane	Natural Gas
GAS CONTROL	IPI PF2	IPI PF2	IPI PF2	IPI PF2
INPUT MAX.	44,000 BTU	45,000 BTU	44,000 BTU	45,000 BTU
INPUT MIN.	35,000 BTU	32,000 BTU	35,000 BTU	32,000 BTU
FE (P.4.1-15)%	56.52%	56.18%	56.52%	56.18%
FLUE SIZES	5/8"	5/8"	5/8"	5/8"
GLASS TYPE	Ceramic	Ceramic	Ceramic	Ceramic
SIZE (W x H x D)	68 1/2" x 36 5/16" x 20 1/16"	68 1/2" x 36 5/16" x 20 1/16"	68 1/2" x 36 5/16" x 20 1/16"	68 1/2" x 36 5/16" x 20 1/16"
VIEWING AREA (W x H)	66 5/8" x 15 1/4"	66 5/8" x 15 1/4"	66 5/8" x 15 1/4"	66 5/8" x 15 1/4"

ENCLAVE 72

MODELS >	MQVL72NE2	MQVL72LPE2	MQVLBG72LPE2	MQVLBG72NE2
FUEL	Natural Gas	Propane	Propane	Natural Gas
GAS CONTROL	IPI PF2	IPI PF2	IPI PF2	IPI PF2
INPUT MAX.	50,000 BTU	50,000 BTU	50,000 BTU	50,000 BTU
INPUT MIN.	34,000 BTU	39,000 BTU	39,000 BTU	34,000 BTU
FE (P.4.1-15)%	60.32%	60.32%	60.32%	60.32%
FLUE SIZES	5/8"	5/8"	5/8"	5/8"
GLASS TYPE	Ceramic	Ceramic	Ceramic	Ceramic
SIZE (W x H x D)	86 1/16" x 36 5/16" x 18 7/8"	86 1/16" x 36 5/16" x 18 7/8"	86 1/16" x 36 5/16" x 18 7/8"	86 1/16" x 36 5/16" x 18 7/8"
VIEWING AREA (W x H)	78 5/8" x 15 1/4"	78 5/8" x 15 1/4"	78 5/8" x 15 1/4"	78 5/8" x 15 1/4"

INFINITE 35

MODELS >	MORB4436NE2	MORB4436LPE2
FUEL	Natural Gas	Propane
GAS CONTROL	IPI / PF2	IPI / PF2
INPUT MAX.	31,500 BTU	31,000 BTU
INPUT MIN.	22,500 BTU	23,000 BTU
FE (P.4.1-15)%	54.87%	54.87%
FLUE SIZES	5/7"	5/7"
GLASS TYPE	Ceramic	Ceramic
SIZE (W x H x D)	46 1/8" x 37 5/8" x 16 1/2"	46 1/8" x 37 5/8" x 16 1/2"
VIEWING AREA (W x H)	36 1/4" x 16 1/8"	36 1/4" x 16 1/8"

INFINITE 42

MODELS >	MORB5143NE2	MORB5143LPE2
FUEL	Natural Gas	Propane
GAS CONTROL	IPI / PF2	IPI / PF2
INPUT MAX.	38,500 BTU	38,000 BTU
INPUT MIN.	22,500 BTU	29,500 BTU
FE (P.4.1-15)%	59.94%	59.94%
FLUE SIZES	5/7"	5/7"
GLASS TYPE	Ceramic	Ceramic
SIZE (W x H x D)	53 1/8" x 37 5/8" x 16 1/2"	53 1/8" x 37 5/8" x 16 1/2"
VIEWING AREA (W x H)	43 1/4" x 16 1/8"	43 1/4" x 16 1/8"

INFINITE 60

MODELS >	MORB6961NE2	MORB6961LPE2
FUEL	Natural Gas	Propane
GAS CONTROL	IPI / PF2	IPI / PF2
INPUT MAX.	59,000 BTU	58,500 BTU
INPUT MIN.	42,500 BTU	46,000 BTU
FE (P.4.1-15)%	53.21%	53.21%
FLUE SIZES	7/10"	7/10"
GLASS TYPE	Ceramic	Ceramic
SIZE (W x H x D)	72" x 45 3/8" x 20 1/2"	72" x 45 3/8" x 20 1/2"
VIEWING AREA (W x H)	61 1/4" x 16 1/8"	61 1/4" x 16 1/8"

SENTINEL

MODELS >	FDV350NE2	FDV350LPE2
FUEL	Natural Gas	Propane
GAS CONTROL	Millivolt / IPI	Millivolt / IPI
INPUT MAX.	37,000 BTU	35,000 BTU
INPUT MIN.	29,000 BTU	27,000 BTU
FE (P.4.1-15)%	67.90%	70.10%
FLUE SIZES	4/7"	4/7"
GLASS TYPE	Ceramic	Ceramic
SIZE (W x H x D)	27 5/16" x 30 3/8" x 19"	27 5/16" x 30 3/8" x 19"

SERENE 47

MODELS >	ZCVRB47N/NE	MQZCVRB47NE2	ZCVRB47LP/LPE	MQZCVRB47LPE2
FUEL	Natural Gas	Natural Gas	Propane	Propane
GAS CONTROL	Millivolt / IPI	Millivolt / IPI	Millivolt / IPI	Millivolt / IPI
INPUT MAX.	24,500 BTU	24,500 BTU	24,500 BTU	24,500 BTU
INPUT MIN.	16,500 BTU	16,500 BTU	20,500 BTU	20,500 BTU
FE (P.4.1-15)%	55.62% / 57.31%	57.31%	55.01% / 57.10%	57.10%
FLUE SIZES	4/7"	4/7"	4/7"	4/7"
GLASS TYPE	Tempered	Tempered	Tempered	Tempered
SIZE (W x H x D)	46 5/8" x 38 5/8" x 17 3/4"	46 5/8" x 38 5/8" x 17 3/4"	46 5/8" x 38 5/8" x 17 3/4"	46 5/8" x 38 5/8" x 17 3/4"
VIEWING AREA (W x H)	41 5/8" x 15 7/8"	41 5/8" x 15 7/8"	41 5/8" x 15 7/8"	41 5/8" x 15 7/8"

SERENE 60

MODELS >	MQZCVRB60NE2	MQZCVRB60LPE2	ZCVRB60N/NE	ZCVRB60LP/LPE
FUEL	Natural Gas	Propane	Natural Gas	Propane
GAS CONTROL	Millivolt / IPI	Millivolt / IPI	Millivolt / IPI	Millivolt / IPI
INPUT MAX.	35,000 BTU	35,000 BTU	35,000 BTU	35,000 BTU
INPUT MIN.	23,000 BTU	28,000 BTU	23,000 BTU	28,000 BTU
FE (P.4.1-15)%	55.27% / 56.66%	55.27% / 56.66%	55.27% / 56.66%	55.27% / 56.66%
FLUE SIZES	5"/8"	5"/8"	5"/8"	5"/8"
GLASS TYPE	Tempered	Tempered	Tempered	Tempered
SIZE (W x H x D)	66 3/16" x 39 9/16" x 19 3/8"	66 3/16" x 39 9/16" x 19 3/8"	66 3/16" x 39 9/16" x 19 3/8"	66 3/16" x 39 9/16" x 19 3/8"
VIEWING AREA (W x H)	61 1/8" x 19 15/16"	61 1/8" x 19 15/16"	61 1/8" x 19 15/16"	61 1/8" x 19 15/16"

SERENE 72

MODELS >	ZCVRB72N	ZCVRB72NE MQZCVRB72NE2	ZCVRB72LP	ZCVRB72LPE MQZCVRB72LPE2
FUEL	Natural Gas	Natural Gas	Propane	Propane
GAS CONTROL	Millivolt	IPI	Millivolt	IPI
INPUT MAX.	50,000 BTU	50,000 BTU	50,000 BTU	50,000 BTU
INPUT MIN.	34,000 BTU	34,000 BTU	39,000 BTU	39,000 BTU
FE (P.4.1-15)%	53.14%	53.64%	53.14%	53.64%
FLUE SIZES	5"/8"	5"/8"	5"/8"	5"/8"
GLASS TYPE	Tempered	Tempered	Tempered	Tempered
SIZE (W x H x D)	78 3/4" x 42" x 19 3/8"	78 3/4" x 42" x 19 3/8"	78 3/4" x 42" x 19 3/8"	78 3/4" x 42" x 19 3/8"
VIEWING AREA (W x H)	73 7/8" x 20"	73 7/8" x 20"	73 7/8" x 20"	73 7/8" x 20"

SKYLINE

MODELS >	ZCVRB3622N/NE	ZCVRB3622LP/LPE	MQRB4236NT/NTE	MQRB4236LPT/LPTE
FUEL	Natural Gas	Propane	Natural Gas	Propane
GAS CONTROL	Millivolt / IPI	Millivolt / IPI	Millivolt / IPI	Millivolt / IPI
INPUT MAX.	17,500 BTU	17,500 BTU	24,000 BTU	24,000 BTU
INPUT MIN.	12,000 BTU	14,000 BTU	18,000 BTU	19,000 BTU
FE (P.4.1-15)%	61.36% / 65.82%	62.72% / 64.55%	54.84% / 57.05%	57.15% / 59.13%
FLUE SIZES	4/7"	4/7"	4/7"	4/7"
GLASS TYPE	Tempered	Tempered	Tempered	Tempered
SIZE (W x H x D)	36"x 37 1/8" x 17 7/16"	36"x 37 1/8" x 17 7/16"	42"x 37" x 16 7/16"	42"x 37" x 16 7/16"
VIEWING AREA (W x H)	29 3/4" x 16 1/8"	29 3/4" x 16 1/8"	33 3/8" x 20 3/8"	33 3/8" x 20 3/8"

SOLACE 36

	SOLACE I	SOLACE I	SOLACE II	SOLACE II
MODELS >	MQHBZDV3636N/NE	MQHBZDV3636LP/LPE	HBZDV3624N/NE	HBZDV3624LP/LPE
FUEL	Natural Gas	Propane	Natural Gas	Propane
GAS CONTROL	Millivolt / IPI	Millivolt / IPI	Millivolt / IPI	Millivolt / IPI
INPUT MAX.	30,500 BTU	29,000 BTU	24,000 BTU	22,000 BTU
INPUT MIN.	20,600 BTU	22,200 BTU	14,000 BTU	15,000 BTU
FE (P.4.1-15)%	61.98% / 63.92%	67.63% / 69.25%	50.48% / 52.30%	52.59% / 54.24%
FLUE SIZES	4/7"	4/7"	4/7"	4/7"
GLASS TYPE	Ceramic	Ceramic	Tempered	Tempered
SIZE (W x H x D)	36" x 34 13/16" x 16 7/16"	36" x 34 13/16" x 16 7/16"	36" x 34 13/16" x 16 7/16"	36" x 34 13/16" x 16 7/16"
VIEWING AREA (W x H)	29 3/4" x 18 5/8"	29 3/4" x 18 5/8"	29 3/4" x 18 5/8"	29 3/4" x 18 5/8"

SOLACE 42**MODELS >**

FUEL
GAS CONTROL
INPUT MAX.
INPUT MIN.
FE (P.4.1-15)%
FLUE SIZES
GLASS TYPE
SIZE (W x H x D)
VIEWING AREA (W x H)

SOLACE I

MQHBZDV4236N/NE
 Natural Gas
 Millivolt / IPI
 30,500 BTU
 20,600 BTU
 61.98% / 63.92%
 4/7"
 Ceramic
 42" x 37" x 16 7/16"
 33 3/8" x 20 3/8"

SOLACE I

MQHBZDV4236LP/LPE
 Propane
 Millivolt / IPI
 29,000 BTU
 22,200 BTU
 67.63% / 69.25%
 4/7"
 Ceramic
 42" x 37" x 16 7/16"
 33 3/8" x 20 3/8"

SOLACE II

HBZDV4224N/NE
 Natural Gas
 Millivolt / IPI
 24,000 BTU
 14,000 BTU
 55.69% / 57.81%
 4/7"
 Tempered
 42" x 37" x 16 7/16"
 33 3/8" x 20 3/8"

SOLACE II

HBZDV4224LP/LPE
 Propane
 Millivolt / IPI
 22,000 BTU
 15,000 BTU
 57.03% / 59.09%
 4/7"
 Tempered
 42" x 37" x 16 7/16"
 33 3/8" x 20 3/8"

SOLACE 47**MODELS >**

FUEL
GAS CONTROL
INPUT MAX.
INPUT MIN.
FE (P.4.1-15)%
FLUE SIZES
GLASS TYPE
SIZE (W x H x D)
VIEWING AREA (W x H)

SOLACE I

MQHBZDV4736N/NE
 Natural Gas
 Millivolt / IPI
 40,000 BTU
 27,000 BTU
 60.39% / 61.88%
 4/7"
 Tempered
 47 1/8" x 43 1/16" x 19 7/16"
 39 1/2" x 26 3/8"

SOLACE I

MQHBZDV4736LP/LPE
 Propane
 Millivolt / IPI
 36,000 BTU
 30,000 BTU
 53.79% / 54.90%
 4/7"
 Tempered
 47 1/8" x 43 1/16" x 19 7/16"
 39 1/2" x 26 3/8"

SOLARA II**MODELS >**

FUEL
GAS CONTROL
INPUT MAX.
INPUT MIN.
FE (P.4.1-15)%
FLUE SIZES
GLASS TYPE
SIZE (W x H x D)
VIEWING AREA (W x H)

ZCV3622N/NE

Natural Gas
 Millivolt / IPI
 18,000 BTU
 13,000 BTU
 60.54% / 63.46%
 4/7"
 Tempered
 36" x 37 1/8" x 17 7/16"
 29 3/4" x 18 5/8"

ZCV3622LP/LPE

Propane
 Millivolt / IPI
 18,000 BTU
 15,000 BTU
 62.09% / 65.09%
 4/7"
 Tempered
 36" x 37 1/8" x 17 7/16"
 29 3/4" x 18 5/8"

TITAN**MODELS >**

FUEL
INPUT MAX.
INPUT MIN.
FE (P.4.1-15)%
FLUE SIZES
GLASS TYPE
SIZE (W x H x D)

FDV200SN/NE/NE2

Natural Gas
 28,500 BTU
 19,500 BTU
 64.14% / 68.56%
 4/7"
 Ceramic
 23 13/32" x 30 9/16" x 18 19/32"

FDV200SLP/LPE/LPE2

Propane
 26,000 BTU
 20,000 BTU
 67.47% / 69.89%
 4/7"
 Ceramic
 23 13/32" x 30 9/16" x 18 19/32"

VANTAGE**MODELS >**

FUEL
GAS CONTROL
INPUT MAX.
INPUT MIN.
FE (P.4.1-15)%
FLUE SIZES
GLASS TYPE
SIZE (W x H x D)
VIEWING AREA (W x H)

FDV451NE2

Natural Gas
 IPI
 34,500 BTU
 23,750 BTU
 67.72%
 4/7"
 Ceramic
 27 1/8" x 33 1/2" x 20 5/16"
 20" x 16 5/16"

FDV451LPE2

Propane
 IPI
 31,000 BTU
 24,500 BTU
 74.06%
 4/7"
 Single
 27 1/8" x 33 1/2" x 20 5/16"
 20" x 16 5/16"

MQFDV453NE2

Natural Gas
 IPI
 34,500 BTU
 23,750 BTU
 67.72%
 4/7"
 Ceramic x3
 27 1/8" x 33 1/2" x 20 5/16"
 20" x 16 5/16"

MQFDV453LPE2

Propane
 IPI
 31,000 BTU
 24,500 BTU
 74.06%
 4/7"
 Ceramic x3
 27 1/8" x 33 1/2" x 20 5/16"
 20" x 16 5/16"

WARRANTY



View the Limited Lifetime Warranty here.

LIMITED LIFETIME WARRANTY

This Limited Lifetime Warranty applies only while the unit remains at the site of the original installation and only if the unit is installed inside the continental United States, Alaska, Hawaii, and Canada. The warranty applies only if the unit is installed and operated in accordance with the printed instructions and in compliance with applicable installation and building codes and good trade practices.

BASIC ONE YEAR WARRANTY

During the first year after installation, we will provide a replacement for any component part of your unit found to be defective in materials or workmanship, including labour costs. Repair work requires prior approval by Kingsman, labour costs are based on a predetermined rate schedule and any repair work must be done through an authorized Kingsman dealer. (Excluded Components: Accent Light Bulbs, Glass, Gasketing and Paint.)

LIMITED LIFETIME WARRANTY

The heat exchanger, combustion chamber and burner of every Kingsman product excluding the Outdoor Firepit are warranted against materials or workmanship during the period the product is owned by the original owner. The part to be replaced must be returned to our distributor in exchange for the replacement part. Any labor, material, freight and/or handling charges associated with any repair or replacement pursuant to this Limited Lifetime Warranty will not be covered by this warranty.

GENERAL TERMS

In lieu of providing a replacement part, we may, at our option, provide the distributor's component purchase price from us or a credit equal to the distributor's component purchase price from us toward the purchase of any new unit which we distribute. If a credit is given in lieu of a replacement part, the rating plate from the unit being replaced must be submitted on a warranty claim, and the unit being replaced must be made available to our distributor for disposition.

In establishing the date of installation for any purpose, including determination of the starting date for the term of this Limited Lifetime Warranty, reasonable proof of the original installation date must be presented*, otherwise the effective date will be based upon the date of manufacture plus thirty (30) days. We will not be responsible for and you, the user, will pay for: (a) damages caused by accident, abuse, negligence, misuse, riot, fire, flood, or Acts of God (b) damages caused by operating the unit where there is a corrosive atmosphere containing chlorine, fluorine, or any other damaging chemicals (other than in a normal residential environment) (c) damages caused by any unauthorized alteration or repair of the unit affecting its stability or performance (d) damages caused by improper matching or application of the unit or the unit's components (e) damages caused by failing to provide proper maintenance and service to the unit (f) any expenses incurred for erecting, disconnecting or dismantling the unit (g) parts or supplies used in connection with service or maintenance (h) damage repairs, inoperation or inefficiency resulting from faulty installation or application (i) electricity or fuel costs or any increase in electricity or fuel cost whatsoever including additional or unusual use of supplemental electric heat.

We shall not be liable for any incidental, consequential, or special damages or expenses in connection with any use or failure of this unit. We have not made and do not make any representation or warranty of fitness for a particular use or purpose, and there is no implied condition of fitness for a particular use or purpose. We make no express warranties except as stated in this Limited Lifetime Warranty. No one is authorized to change this Limited Lifetime Warranty or to create for us any other obligation or liability in connections with this unit. Any implied warranties shall last for one year after the original installation. Some states and provinces do not allow the exclusion or limitation of incidental or consequential damages or do not allow limitations on how long an implied warranty or condition lasts, so the above limitations or exclusions may not apply to you. The provisions of this limited warranty are in additions to and not a modification of or subtraction from any statutory warranties and other rights and remedies provided by law.

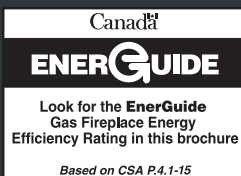

Marquis Fireplaces maintains a program of continuous testing, refinement and improvements of all its products. Some aspect of units shown here may be changed at any time without notice or obligation.



Crafted entirely in Canada, each Marquis fireplace is built to the highest standards and made to last.

LIMITED LIFETIME WARRANTY